

JVC



COMPACT COMPONENT SYSTEM

KOMPAKT-KOMPONENTEN-SYSTEM

SYSTEME DE COMPOSANTS COMPACT

KOMPACTO KOMPONENTEN-SYSTEEM

SISTEMAS DE COMPONENTES COMPACTOS

IMPIANTO A COMPONENTI COMPATTO

CA-D752TR

COMPACT
disc
DIGITAL AUDIO

R-D-S EON

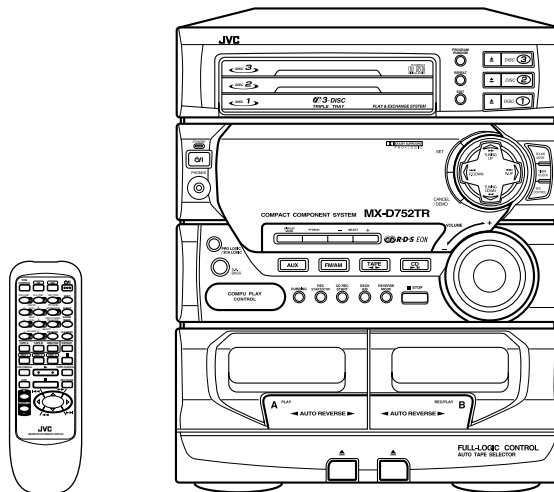

INSTRUCTIONS
BEDIENUNGSANLEITUNG
MANUEL D'INSTRUCTIONS
GEBRUIKSAANWIJZING
MANUAL DE INSTRUCCIONES
ISTRUZIONI

For Customer Use:

Enter below the Model No. and Serial No. which are located either on the rear, bottom or side of the cabinet. Retain this information for future reference.

Model No. _____

Serial No. _____

GVT0004-006A

[E]

Warnings, Cautions and Others / Warnung, Achtung und sonstige Hinweise / Mises en garde, précautions et indications diverses / Waarschuwingen, voorzorgen en andere mededelingen / Avisos, precauciones y otras notas / Avvertenze e precauzioni da osservare

IMPORTANT for the U.K.

DO NOT cut off the mains plug from this equipment. If the plug fitted is not suitable for the power points in your home or the cable is too short to reach a power point, then obtain an appropriate safety approved extension lead or consult your dealer.

BE SURE to replace the fuse only with an identical approved type, as originally fitted.

If nonetheless the mains plug is cut off ensure to remove the fuse and dispose of the plug immediately, to avoid a possible shock hazard by inadvertent connection to the mains supply.

If this product is not supplied fitted with a mains plug then follow the instructions given below:

IMPORTANT:

DO NOT make any connection to the terminal which is marked with the letter E or by the safety earth symbol or coloured green or green-and-yellow.

The wires in the mains lead on this product are coloured in accordance with the following code:

Blue : Neutral
Brown : Live

As these colours may not correspond with the coloured markings identifying the terminals in your plug proceed as follows:

The wire which is coloured blue must be connected to the terminal which is marked with the letter N or coloured black.

The wire which is coloured brown must be connected to the terminal which is marked with the letter L or coloured red.

IF IN DOUBT - CONSULT A COMPETENT ELECTRICIAN.

Caution — ⏻/! switch!

Disconnect the mains plug to shut the power off completely. The ⏻/! switch in any position does not disconnect the mains line. The power can be remote controlled.

Achtung — ⏻/!-Schalter!

Den Netzstecker aus der Steckdose ziehen, um die Stromversorgung vollkommen zu unterbrechen. Der Schalter ⏻/! unterbricht in keiner Stellung die Stromversorgung vollkommen. Die Stromversorgung kann mit der Fernbedienung ein- und ausgeschaltet werden.

Attention — Commutateur ⏻/!

Déconnecter la fiche de secteur pour couper complètement le courant. Le commutateur ⏻/! ne coupe jamais complètement la ligne de secteur, quelle que soit sa position. Le courant peut être télécommandé.

Voorzichtig — ⏻/! schakelaar!

Om de stroomtoevoer geheel uit te schakelen, trekt u de stekker uit het stopcontact. Anders zal er altijd een geringe hoeveelheid stroom naar het apparaat lopen, ongeacht de stand van de ⏻/! schakelaar. U kunt het apparaat ook met de afstandsbediening aan- en uitschakelen.

Precaución — Interruptor ⏻/!

Desconectar el cable de alimentación para desactivar la alimentación totalmente. Cualquiera que sea la posición de ajuste del interruptor ⏻/!, la alimentación no es cortada completamente. La alimentación puede ser controlada remotamente.

Attenzione — L'interruttore ⏻/!

Disinserire la spina del cavo di alimentazione dalla presa della rete elettrica per staccare completamente l'alimentazione. L'interruttore ⏻/! in nessuna posizione stacca la linea di alimentazione elettrica principale. È possibile il controllo remoto dell'alimentazione.

Per l'Italia:

"Si dichiara che il questo prodotto di marca JVC è conforme alle prescrizioni del Decreto Ministeriale n.548 del 28/08/95 pubblicato sulla Gazzetta Ufficiale della Repubblica Italiana n.301 del 28/12/95."

CAUTION

To reduce the risk of electrical shocks, fire, etc.:

1. Do not remove screws, covers or cabinet.
2. Do not expose this appliance to rain or moisture.

ACHTUNG

Zur Verhinderung von elektrischen Schlägen, Brandgefahr, usw:

1. Keine Schrauben lösen oder Abdeckungen entfernen und das Gehäuse nicht öffnen.
2. Dieses Gerät weder Regen noch Feuchtigkeit aussetzen.

ATTENTION

Afin d'éviter tout risque d'électrocution, d'incendie, etc.:

1. Ne pas enlever les vis ni les panneaux et ne pas ouvrir le coffret de l'appareil.
2. Ne pas exposer l'appareil à la pluie ni à l'humidité.

VOORZICHTIG

Ter vermindering van gevaar voor brand, elektrische schokken, enz.:

1. Verwijder geen schroeven, panelen of de behuizing.
2. Stel het toestel niet bloot aan regen of vocht.

PRECAUCIÓN

Para reducir riesgos de choques eléctricos, incendio, etc.:

1. No extraiga los tornillos, los cubiertas ni la caja.
2. No exponga este aparato a la lluvia o a la humedad.

ATTENZIONE

Per ridurre il rischio di shock elettrici, incendi, ecc.:

1. Non togliate viti, coperchi o la scatola.
2. Non esponete l'apparecchio alla pioggia e all'umidità.

Caution: Proper Ventilation

To avoid risk of electric shock and fire, and to prevent damage, locate the apparatus as follows:

- 1 Front:
No obstructions and open spacing.
- 2 Sides/ Top/ Back:
No obstructions should be placed in the areas shown by the dimensions below.
- 3 Bottom:
Place on the level surface. Maintain an adequate air path for ventilation by placing on a stand with a height of 10 cm or more.

Achtung: Ausreichende Belüftung

Zur Vermeidung von elektrischen Schlägen, Feuer und sonstigen Schäden sollte das Gerät unter folgenden Bedingungen aufgestellt werden:

- 1 Vorderseite:
Hindernisfrei und gut zugänglich.
- 2 Seiten- und Rückwände:
Hindernisfrei in allen gegebenen Abständen (s. Abbildung).
- 3 Unterseite:
Die Stellfläche muß absolut eben sein. Sorgen Sie für ausreichende Luftzufuhr durch Aufstellung auf einem Stand mit mindestens 10 cm Höhe.

Attention: Aération correcte

Pour prévenir tout risque de décharge électrique ou d'incendie et éviter toute détérioration, installez l'appareil de la manière suivante:

- 1 Avant:
Bien dégagé de tout objet.
- 2 Côtés/dessus/dessous:
Assurez-vous que rien ne bloque les espaces indiqués sur le schéma ci-dessous.
- 3 Dessous:
Posez l'appareil sur une surface plane et horizontale. Veillez à ce que sa ventilation correcte puisse se faire en le plaçant sur un support d'au moins dix centimètres de hauteur.

Voorzichtig: Goede ventilatie vereist

Om brand, elektrische schokken en beschadiging te voorkomen, moet u het toestel als volgt opstellen:

- 1 Voorkant:
Geen belemmeringen en voldoende ruimte.
- 2 Zijkanten/boven-/onderkant:
Geen belemmeringen plaatsen in de hieronder aangegeven zones.
- 3 Onderkant:
Op vlakke ondergrond plaatsen. Voldoende ventilatieruimte voorzien door het toestel op een onderstel met een hoogte van 10 cm of meer te plaatsen.

Precaución: ventilación correcta

Para evitar el riesgo de descargas eléctricas e incendio y prevenir posibles daños, instale el equipo en un lugar que cumpla los siguientes requisitos:

- 1 Parte frontal:
Sin obstrucciones, espacio abierto.
- 2 Lados/parte superior/parte posterior:
No debe haber ninguna obstrucción en las áreas mostradas por las dimensiones de la siguiente figura.
- 3 Parte inferior:
Sitúe el equipo sobre una superficie nivelada. Mantenga un espacio adecuado para permitir el paso del aire y una correcta ventilación, situando el equipo sobre un soporte de 10 o más cm de altura.

Attenzione: Per una corretta ventilazione

Per prevenire il rischio di scosse elettriche e di incendio ed evitare possibili danni, collocare le apparecchiature nel modo seguente:

- 1 Parte anteriore:
Nessun ostacolo e spazio libero.
- 2 Lati/Parte superiore/Retro:
Lasciare libere le zone indicate dalle dimensioni di seguito.
- 3 Base:
Collocare su una superficie piana. Consentire un'adeguata ventilazione dell'impianto appoggiandolo su un tavolino alto almeno 10 cm.

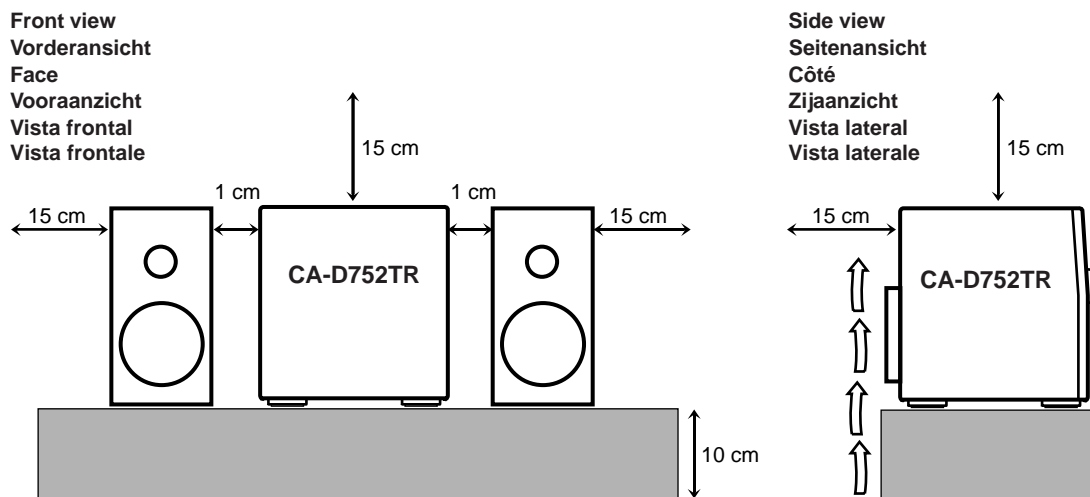

IMPORTANT FOR LASER PRODUCTS/ WICHTIGER HINWEIS FÜR LASER-PRODUKTE / IMPORTANT POUR LES PRODUITS LASER / BELANGRIJKE INFORMATIE VOOR LASERPRODUKTEN / IMPORTANTE PARA LOS PRODUCTOS LÁSER / IMPORTANTE PER I PRODOTTI LASER

REPRODUCTION OF LABELS/ANBRINGUNGSORTE FÜR LASER-PRODUKTE/REPRODUCTION DES ETIQUETTES/VERKLARING VAN DE LABELS/REPRODUCCIÓN DE ETIQUETAS/RIPRODUZIONE DELLE ETICHETTE

- | | |
|--|---|
| ① CLASSIFICATION LABEL, PLACED ON REAR ENCLOSURE | ② WARNING LABEL, PLACED INSIDE THE UNIT |
| ① KLASSIFIKATIONSETIKETTE AN DER RÜCKSEITE | ② WARNETIKETTE IM GERÄTEINNEREN |
| ① ETIQUETTE DE CLASSIFICATION, PLACÉE A L'ARRIÈRE DU COFFRET | ② ETIQUETTE D'AVERTISSEMENT PLACÉE À L'INTERIEUR DE L'APPAREIL |
| ① KLASSIFIKATIELABEL, OP DE ACHTERZIJDE VAN HET APPARAAT | ② WAARSCHUWINGSLABEL, IN HET APPARAAT |
| ① ETIQUETA DE CLASIFICACIÓN, PEGADA EN LA PARTE POSTERIOR DE LA CAJA | ② ETIQUETA DE ADVERTENCIA, PEGADA EN EL INTERIOR DE LA UNIDAD |
| ① ETICHETTA DI CLASSIFICAZIONE, SITUATA SUL RIVESTIMENTO POSTERIORE | ② ETICHETTA DI AVVERTENZA, SITUATA ALL'INTERNO DELL'APPARECCHIO |

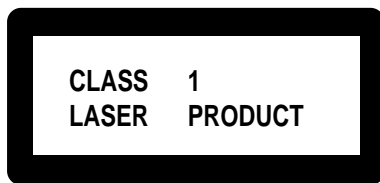

DANGER: Invisible laser radiation when open and interlock failed or defeated. AVOID DIRECT EXPOSURE TO BEAM. (e)	WARNING: Osynlig laserstrålning när denna del är öppnad och spärren är urkopplad. Betrakta ej strålen. (s)	ADVARSEL: Usynlig laserstrålning ved åbning, når sikkerhedsafbrydere er ude af funktion. Undgå udsættelse for stråling (d)	VARO: Avattaessa ja suojalukitus ohitettaessa olet alttiina näkymättömälle lasersäteilylle. Älä katso säteeseen. (f)
---	---	---	---

- | | |
|---|---|
| <ol style="list-style-type: none">1. CLASS 1 LASER PRODUCT2. DANGER: Invisible laser radiation when open and interlock failed or defeated. Avoid direct exposure to beam.3. CAUTION: Do not open the top cover. There are no user serviceable parts inside the Unit; leave all servicing to qualified service personnel. | <ol style="list-style-type: none">1. KLAS 1 LASERPRODUKT2. GEVAARLIJK: Onzichtbare laserstraling wanneer open en de beveiliging faalt of uitgeschakeld is. Voorkom het direkt blootstaan aan de straal.3. VOORZICHTIG: De bovenkap niet openen. Binnenin het toestel bevinden zich geen door de gebruiker te repareren onderdelen: laat onderhoud over aan bekwame vakpersoneel. |
| <ol style="list-style-type: none">1. LASER-PRODUKT DER KLASSE 12. GEFAHR: Unsichtbare Laserstrahlung bei Öffnung und fehlerhafter oder beschädigter Spre. Direkten Kontakt mit dem Strahl vermeiden!3. ACHTUNG: Das Gehäuse nicht öffnen. Das Gerät enthält keinerlei Teile, die vom Benutzer gewartet werden können. Überlassen Sie Wartungsarbeiten bitte qualifizierten Kundendienst-Fachleuten. | <ol style="list-style-type: none">1. PRODUCTO LASER CLASE 12. PELIGRO: En el interior hay radiación láser invisible. Evite el contacto directo con el haz.3. PRECAUCIÓN: No abra la tapa superior. En el interior de la unidad no existen piezas reparables por el usuario; deje todo servicio técnico en manos de personal calificado. |
| <ol style="list-style-type: none">1. PRODUIT LASER CLASSE 12. ATTENTION: Radiation laser invisible quand l'appareil est ouvert ou que le verrouillage est en panne ou désactivé. Eviter une exposition directe au rayon.3. ATTENTION: Ne pas ouvrir le couvercle du dessus. Il n'y a aucune pièce utilisable à l'intérieur. Laisser à un personnel qualifié le soin de réparer votre appareil. | <ol style="list-style-type: none">1. PRODOTTO LASER CLASSE 12. PERICOLO: Radiazione laser invisibile quando l'apparecchio è aperto ed il dispositivo di sicurezza è guasto o disattivato. Evitare l'esposizione diretta ai raggi.3. ATTENZIONE: Non aprire il coperchio superiore. Non vi sono parti adoperabili dall'utente all'interno di questo apparecchio; lasciare tutti i controlli a personale qualificato. |

Thank you for purchasing the JVC Compact Component System.
We hope it will be a valued addition to your home, giving you years of enjoyment.
Be sure to read this instruction manual carefully before operating your new stereo system.
Here you will find all the information you need to set up and use the system.
For questions that are not answered in the manual, contact your dealer.

Features

Easy operation



Great sound



Triple Tray

Three timers

Here are some of the things that make your System powerful and easy to use.

- The controls and operations have been designed to make them very easy to use, so you can spend your time listening to music.
 - With the One Touch Operation feature of JVC's **COMPU PLAY** you can turn on the System and start the radio, the Cassette Deck, or the CD Player with a single touch.
- To get such great sound from such a compact package the System has:
 - Built-in **Dolby Pro Logic** and **Dolby 3ch Logic** effects. Combined with the optional centre and rear speakers, this allows you to enjoy the dynamic, pulsating sound effects of a cinema.
 - Programmed sound mode includes live surround effects **D. CLUB, HALL,** and **STADIUM.** It also includes S.E.A (Sound Effect Amplifier) effects **ROCK, POP,** and **CLASSIC.** You can also register up to three customized settings (MANUAL 1 to 3).
- The System is compatible with RDS (Radio Data System) broadcasting.
 - The EON data enables you to stand-by for desired information.
 - The PTY Search function searches for programmes in the category you wish.
 In addition, Radio Text can be displayed using data sent by station.
- CD changer function can operate 3 discs.
 - Discs can be changed during play using the **TRIPLE TRAY.**
 - Continuous, random or program play of 3 discs.
- The three timers, **Daily Timer, Recording Timer,** and **Sleep Timer** are extremely easy to set.

How This Manual Is Organized

In this manual we have incorporated some special features:

- Basic information that is the same for many different functions is grouped in one place, and not repeated in each procedure. For instance, in the section on playing a CD, we do not repeat the information about setting the volume and the sound conditions, which are discussed in the Common Operations section.
- Name of buttons and controls are written in all capital letters like this: **SOUND MODE.**

The manual has a table of contents to help you quickly look up what you want to know.
We've enjoyed making this manual for you, and hope you will use it to enjoy the sound and many features built into your System.

IMPORTANT PRECAUTIONS

1. Installation of the Unit

- Select a place which is level, dry and neither too hot nor too cold. (Between 5°C and 35°C or 41°F and 95°F.)
- Leave sufficient distance between the Unit and a TV.
- Do not use the Unit in a place subject to vibrations.

2. Power cord

- Do not handle the power cord with wet hands!
- Some power (12 watts) is always consumed as long as the power cord is connected to the wall outlet.
- When unplugging the Unit from the wall outlet, always pull the plug, not the power cord.

3. Malfunctions, etc.

- There are no user-serviceable parts inside. If anything goes wrong, unplug the power cord and consult your dealer.
- Do not insert any metallic object into the Unit.

Table of Contents

Features	1	Using the CD Player	23
How This Manual Is Organized	1	Loading CDs	24
IMPORTANT PRECAUTIONS	1	Basics of Using the CD Player —	
Getting Started	3	Continuous Play	24
Accessories	3	Playing a CD	24
How to Put Batteries in the Remote Control	3	Selecting a Track	25
Using the Remote Control	3	Locating a Track with the Remote Control	
Connecting the FM Antenna	4	Directly	25
Connecting the AM (MW/LW) Antenna	4	Fast Forward / Reverse	25
Connecting the Speakers	5	Changing Discs While Playing	25
Connecting the Optional Speakers	5	Programming the Playing Order of the Tracks	26
Connecting Auxiliary Equipment	6	Checking the Program	27
COMPU PLAY	7	Changing the Program	27
Common Operations	8	Random Play	27
DEMO Mode	8	Repeating a Selection or the Discs	28
Setting the Clock	9	Tray Lock Function	28
Turning the Power On and Off	9	Locking the Trays	28
Turning the System On	9	Unlocking the Trays	28
Turning the System Off	9	Using the Cassette Deck (Playing)	29
Adjusting the Volume	10	Regular Play	30
Balance Adjustment	10	Fast Left and Fast Right	30
Reinforcing the Bass Sound	10	Music Scan	30
Sound Modes	11	Finding the Beginning of the Current Selection	30
Customizing a Sound Mode	11	Finding the Beginning of the Next Selection	30
When a Rear Speaker is Connected	12	Reverse Mode	31
Adjusting the Rear Speaker Level	12	Using the Cassette Deck (Recording)	32
Listening to Auxiliary Equipment	13	Things to Know before You Start Recording	32
Dolby Surround	14	Standard Recording	33
Preparing the Dolby Surround	15	Recording AM Station to Tape	34
Getting Ready To Use Dolby Pro Logic	16	CD Direct Recording	34
Speaker Arrangements for Dolby Pro Logic	16	Auto Edit Recording	34
Setting-up Dolby Pro Logic	16	Tape to Tape Recording (Dubbing)	35
Getting Ready To Use Dolby 3 Channel Logic	17	How to Use the DUBBING Button	35
Speaker Arrangements for Dolby 3 Channel		Using the Timer	36
Logic	17	Setting the Daily Timer	37
Setting-up Dolby 3ch Logic	17	Turning the Daily Timer On and Off	38
Using Dolby Surround	17	Setting the Recording Timer	39
Using the Tuner	18	Turning the Recording Timer On and Off	40
Tuning in a Station	18	Setting the Sleep Timer	40
Switching between Frequency Bands	18	Timer Priority	41
Three Ways to Select a Station	19	Care and Maintenance	42
Presetting Stations	19	Troubleshooting	43
Changing the FM Reception Mode	19	Specifications	44
Receiving FM Stations with RDS	20		
What Information RDS can Provide	20		
Changing the Display	20		
Searching for Programmes by PTY codes	21		
EON Function	21		
ALARM function	22		

Accessories

Check that you have all of the following items, which are supplied with the System.

- AM (MW/LW) Loop Antenna (1)
- Remote Control (1)
- Batteries (2)
- FM Wire Antenna (1)

If any of these items is missing, contact your dealer immediately.

How to Put Batteries in the Remote Control

Match the polarity (+ and -) on the batteries with the + and - markings in the battery compartment.

R6P (SUM-3)/AA (15F)

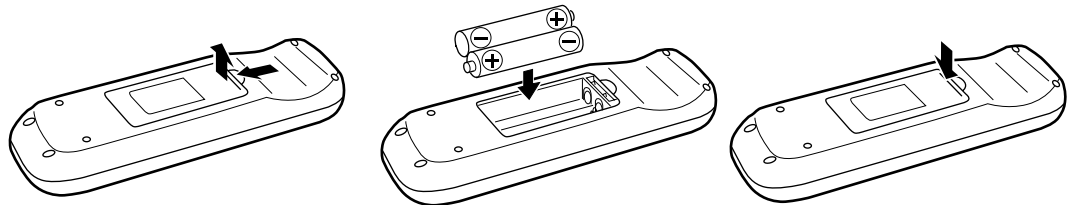

CAUTION: Handle batteries properly.

To avoid battery leakage or explosion:

- Remove batteries when the Remote Control will not be used for a long time.
- When you need to replace the batteries, replace both batteries at the same time with new ones.
- Do not use an old battery with a new one.
- Do not use different types of batteries together.

Using the Remote Control

The Remote Control makes it easy to use many of the functions of the System from a distance of up to 7m (23 feet) away.

You need to point the Remote Control at the remote sensor on the System's front panel.

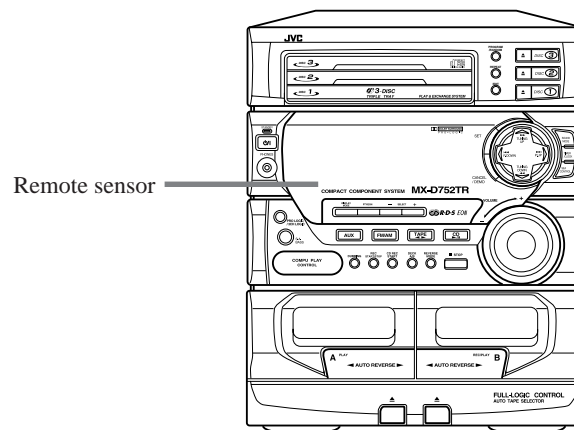

CAUTION: Make all connections before plugging the Unit into an AC power outlet.

Connecting the FM Antenna

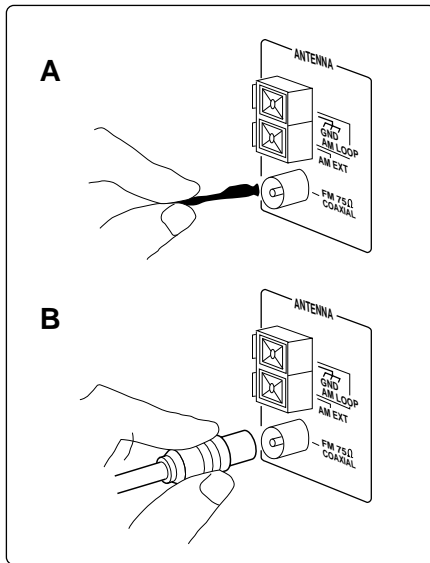

A. Using the Supplied Wire Antenna

The FM Wire Antenna provided can be connected to a FM 75-ohm COAXIAL as temporary measure. Extend the supplied wire antenna horizontally.

B. Using the Standard Type Connector (Not Supplied)

A standard type connector (IEC or DIN 45325) should be connected to the FM 75-ohm COAXIAL terminal.

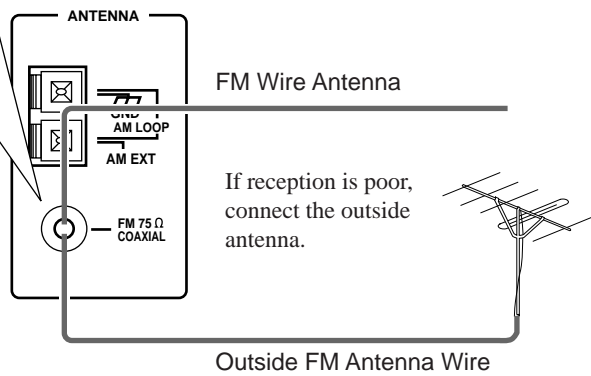

Before attaching a 75-ohm coaxial lead (the kind with a round wire going to an outside antenna), disconnect the supplied FM Wire Antenna.

CAUTION: To avoid noise, keep antennas away from metallic parts of the System, connecting cord and the AC power cord.

Connecting the AM (MW/LW) Antenna

AM Antenna Wire (not supplied)

If reception is poor, connect the outside antenna.

Note: Even when connecting an outside AM antenna, keep the indoor AM loop connected.

AM Loop Antenna

Turn the loop until you have the best reception.

Snap the tabs on the loop into the slots of the base to attach the AM Loop.

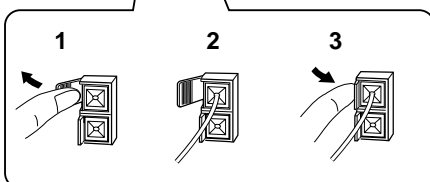

CAUTION: Make all connections before plugging the Unit into an AC power outlet.

Connecting the Speakers

■ Refer to instructions for speakers as well when you connect speakers.

For each speaker, connect one end of the speaker wires to the speaker terminals on the back of the System.

1. Open each of the terminals and insert the speaker wires firmly, then close the terminals.
2. Connect the red (+) and black (-) terminals of the right side speaker to the red (+) and black (-) terminals marked RIGHT on the System.
Connect the red (+) and black (-) terminals of the left side speaker to the red (+) and black (-) terminals marked LEFT on the System.

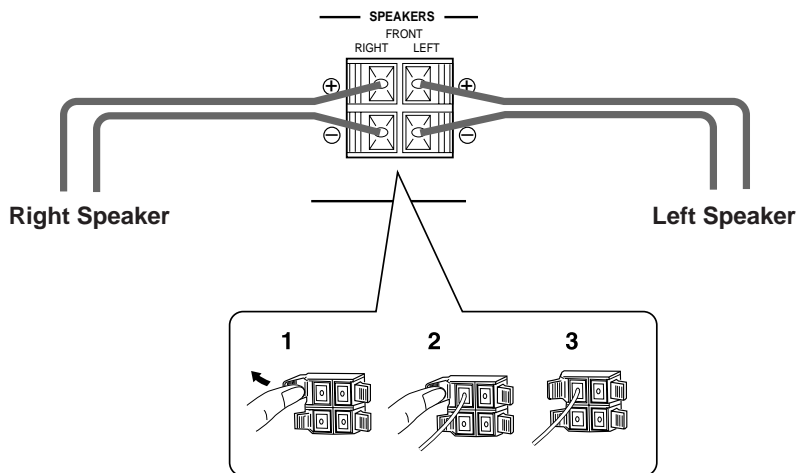

IMPORTANT: Use speakers with the correct impedance only. The correct impedance is indicated on the back panel.
CAUTION: If a TV is installed near the speakers, the TV may display irregular colours. In this case, set the speakers away from the TV.

Connecting the Optional Speakers

Connect the optional centre speaker and rear speakers.

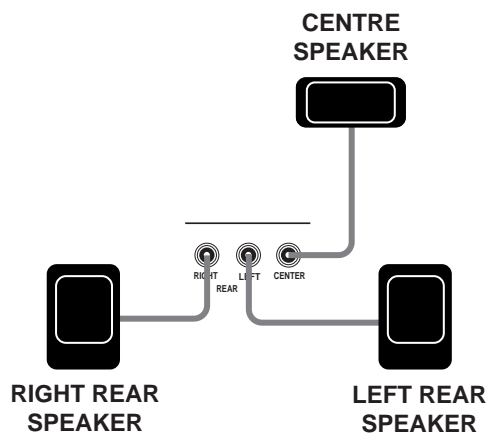

Connecting Auxiliary Equipment

VCR or other equipment

To listen to this source, press AUX.

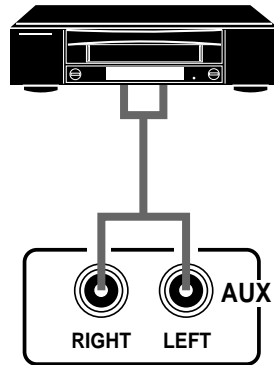

Now you can plug the AC power cord into the wall outlet, and your System is at your command!

COMPU PLAY



COMPU PLAY is JVC's feature that lets you control the most frequently used functions of the System with a single touch.

One Touch Operation starts playing a CD, turns on the radio, plays a tape, etc. with a single press of the play button for that function. What One Touch Operation does for you is to turn the power on, then start the function you have specified. If the Unit is not ready, such as no CD or tape in place, the Unit still powers on so you can insert a CD or tape.

How One Touch Operation works in each case is explained in the section dealing with that function. The COMPU PLAY buttons are:

On the Unit

- CD Player DISC 1 to DISC 3 buttons
- CD Player Open/Close (\blacktriangle) buttons
- CD \blacktriangleright /|| button
- TAPE \blacktriangleleft \blacktriangleright button
- FM/AM button
- AUX button

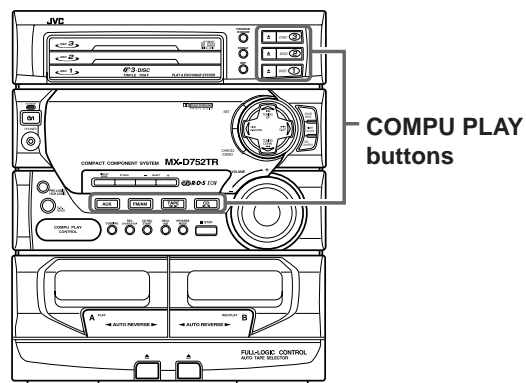

On the Remote Control

- FM button
- AM button
- DISC 1 to DISC 3 buttons
- AUX button

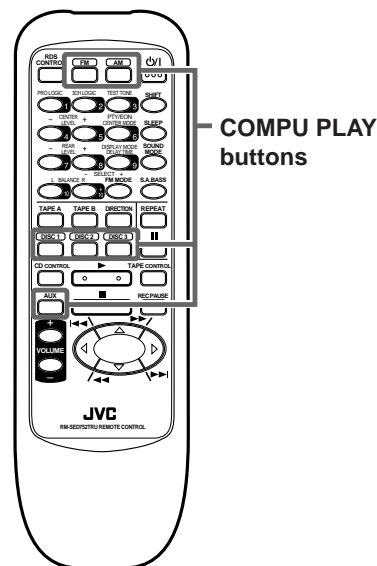

Common Operations

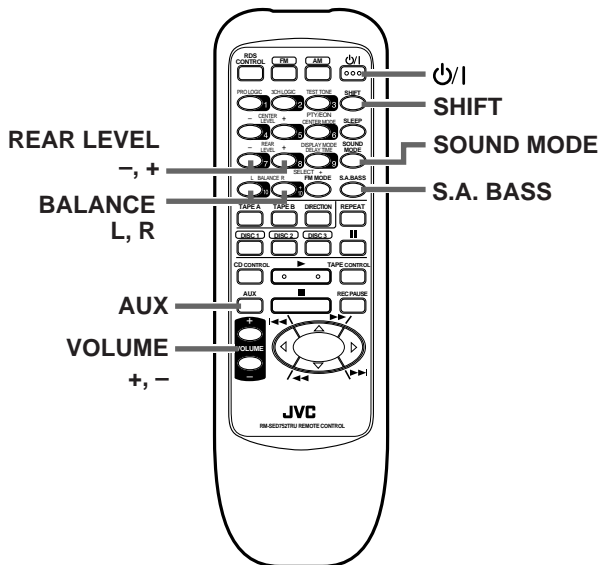
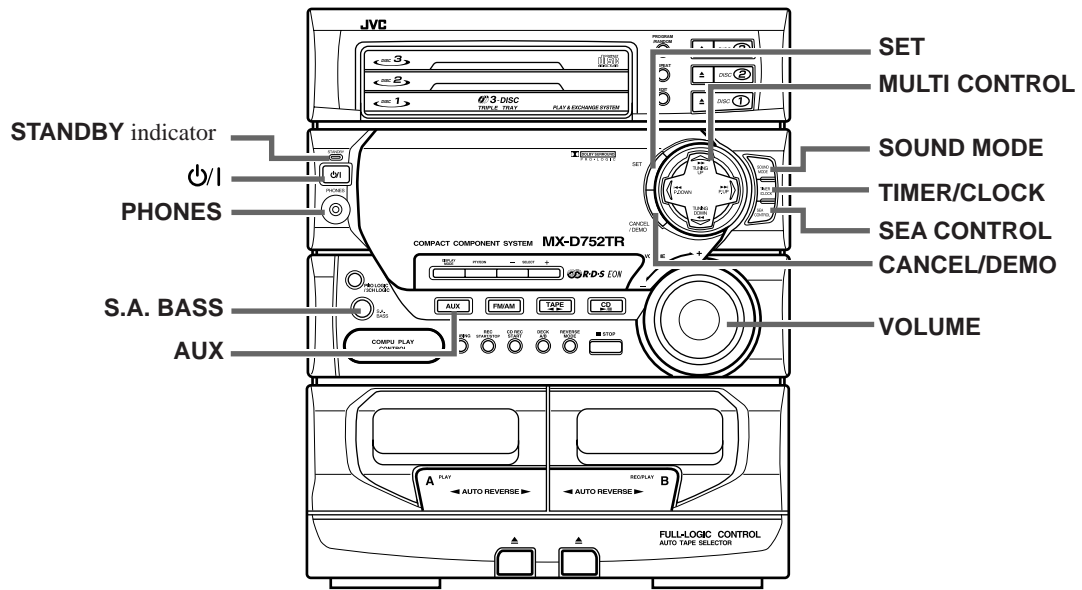

Display

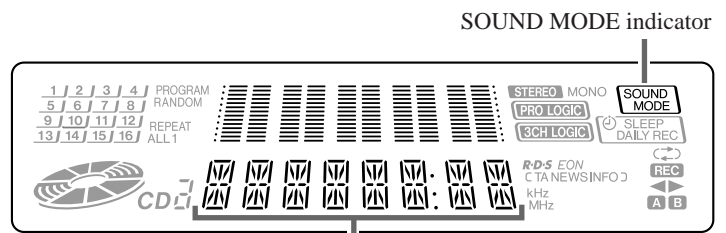

Source, Sound Mode Volume level etc.

When the System is being used, the display shows other items as well. However, we have only shown the items described in this section.

Demo Mode

When the System is connected to an AC power outlet, a Demo automatically starts showing some of the system's features.

The Demo display cycles through the following items repeatedly.

- Scrolling display of "DEMO MODE START".
- Demo of PRO LOGIC and 3CH LOGIC.
- Demo of Sound Modes.
- Demo of S.A. BASS
- Demo of continuous play from DISC 1 to DISC 3.

To turn the Demo off, press any of the operation buttons. "DEMO OFF" appears on the display and the Demo automatically stops.

To turn the Demo on, press CANCEL/DEMO for more than 2 seconds.

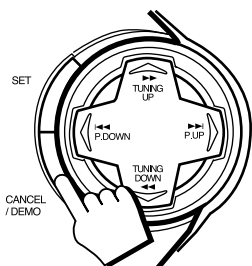

Setting the Clock

1

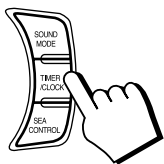

Before operating the unit, set the correct time.
You can set the clock whether the Unit is on or off.

1. Press **TIMER/CLOCK**.

The hour digits begin flashing.



2, 4

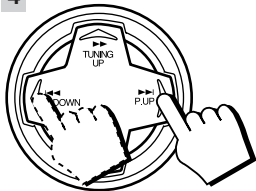

2. Press **◀◀ P. DOWN or ▶▶ P. UP on the MULTI CONTROL to set the hours.**

Press ▶▶ P. UP to increase the hour. Press ◀◀ P. DOWN to decrease the hour. Holding down continuously changes the hour setting more rapidly.

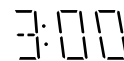

3. Press **SET**.

The minute digits begin flashing.



3, 5

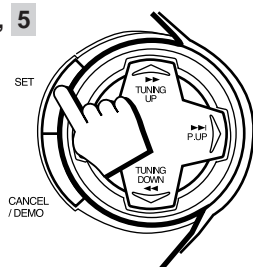

4. Press **◀◀ P. DOWN or ▶▶ P. UP on the MULTI CONTROL to set the minutes.**

Press ▶▶ P. UP to increase the minutes. Press ◀◀ P. DOWN to decrease the minutes. Holding down continuously changes the minute setting more rapidly.

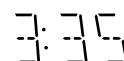

5. Press **SET**.

“CLOCK OK” appears on the display.

The clock stops flashing, and the clock timer starts from 0 second.

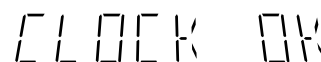

- If the clock is not set, “0:00” will flash instead of the clock indication.
- When the time has been set, **TIMER/CLOCK** can be used to operate the Daily Timer and Recording Timer.
- To adjust the time once the clock has been set, press **TIMER/CLOCK** 5 times and follow the procedure above.

CAUTION: If there is a power failure, the clock loses its setting. The display shows “0:00”, and the clock must be reset.

Turning the Power On and Off

Turning the System On

Press **⏻/⏻**.

“WELCOME” appears on the display and the **STANDBY** indicator goes out.



The System comes on ready to continue in the mode it was in when the power was last turned off.

- If the last thing you were doing was listening to a tape in Deck B, you are now ready to listen to a tape again in Deck B, or you can change to another source.
- If you were listening to the Tuner last, the Tuner comes on playing the station it was last set to.

Turning the System Off

Press **⏻/⏻** again.

“GOOD BYE” appears on the display for a while and the **STANDBY** indicator lights up. The clock time appears on the display.

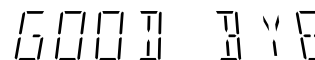

- Some power (12 watts) is always consumed even though the power is on standby.
- To switch off the Unit completely, unplug the AC power cord from the AC outlet. When you unplug the AC power cord, the clock will be reset to 0:00 immediately, and preset Tuner stations will be erased in a few days.

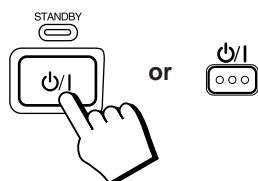

Adjusting the Volume

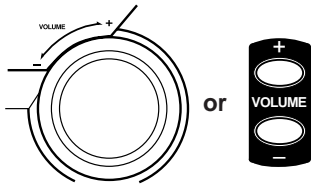

Turn VOLUME clockwise to increase the volume or anticlockwise to decrease it. Turning VOLUME quickly also adjusts the volume level quickly. When using the Remote Control, press VOLUME + to increase the volume or press VOLUME - to decrease it. You can adjust the volume level between 0 and 50.

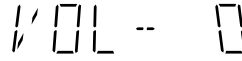

CAUTION: The Volume cannot be adjusted while the Unit is on STANDBY. DO NOT turn on the Unit and/or start playing any source without setting the VOLUME control to 0; otherwise, the sudden blast of sound can damage your hearing, speakers and/or headphones.

For private listening

Connect a pair of headphones to the PHONES jack. No sound comes out of the speakers. Be sure to turn down the volume before connecting or putting on headphones.



Balance Adjustment

You can use the Remote Control to adjust the left and right balance of the speakers.

1. Press SHIFT.

2. Press BALANCE L (10) or R (+10).

The display changes to show the balance adjustment.

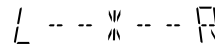

Pressing L (10) moves the pointer to the left, pressing R (+10) moves the pointer to the right.

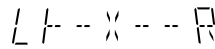

Display when set for no sound from the right speaker.

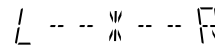

Display at the centre position.

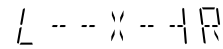

Display when set for no sound from the left speaker.

■ The balance is normally set to the centre position.

Note: If no adjustments are made for 2 seconds in balance adjustment mode, the display reverts to the previous display.

Reinforcing the Bass Sound

S.A. (Signal Adaptive) BASS adjusts low tones at low volume to enhance their effect. When the volume level is low, this enhances low tones that are normally difficult to hear and adjusts low tones to a fixed level to reduce low tone distortion.

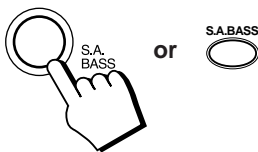

Press S.A. BASS.

Pressing S.A. (Signal Adaptive) BASS changes the bass setting in the following order: → SA-BASS1 → SA-BASS2 → OFF → (back to the beginning)

The S.A. BASS indicator lights up, and “SA-BASS1” or “SA-BASS2” appears on the display for three seconds.

■ SA-BASS2 enhances low tones more than SA-BASS1.

To cancel the effect, press S.A. BASS until “OFF” appears on the display. The button light goes out.

To recall the previous S.A. BASS mode, press S.A. BASS once.

■ When listening to recording with low volume low tones, the difference between SA-BASS1 and SA-BASS2 is clear. When listening to recording with louder low tones, however, the difference between SA-BASS1 and SA-BASS2 may not be so clear.

Sound Modes

The System has some preset sound effects that give you control of the way your music sounds, so you can tailor it for your room and for the quality of the source. We can give you some idea of how each one affects the music, but the only way to really tell is to try them yourself.

You can also create up to three of your own customized S.E.A. (Sound Effect Amplifier) settings and store them in the Unit's memory (MANUAL 1, MANUAL 2, MANUAL 3).

- The preset sound modes include modes using surround effects and modes using S.E.A. effects.
- Sound Mode effects cannot be recorded.

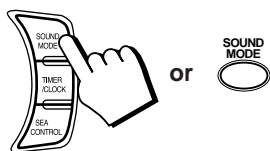

To get an effect, press SOUND MODE repeatedly until the Sound Mode you want appears on the display. The Sound Mode selected will appear on the display for three seconds. When a surround effect mode is selected, the frame around the SOUND MODE indicator will light up. When a S.E.A. effect mode is selected, the SOUND MODE indicator will light up.

Each time you press SOUND MODE, the Sound Mode changes as follows:

→ D. CLUB → HALL → STADIUM → ROCK → POP → CLASSIC → MANUAL 1 →
MANUAL 2 → MANUAL 3 → OFF → (back to the beginning)

Surround effect modes

<p>D. CLUB (Dance Club) HALL STADIUM</p>	<p>Increases resonance and bass. Adds depth and brilliance to the sound, like in a concert hall. Adds clarity and spreads the sound, like in an outdoor stadium.</p>	
---	--	---

S.E.A. effect modes

<p>ROCK POP CLASSIC</p>	<p>Boosts low and high frequencies. Good for vocal music. Set for wide and dynamic sound stereo systems.</p>	
--	--	---

To cancel an effect, press SOUND MODE until "OFF" appears on the display. The SOUND MODE indicator goes out.

To recall the previous Sound Mode, press SOUND MODE once.

Customizing a Sound Mode

You can change an existing sound mode to suit your own preferences. These changed settings can be stored in the Unit's sound mode memory.

1. Select the Sound Mode you want to change.

If you select D. CLUB, HALL, or STADIUM, the surround effect remains unchanged, but you can adjust the S.E.A. effect.

2. Press SEA CONTROL.

The low tone section of the tone equalizer flashes. Once "SEA CONT" appears, the low tone levels will appear.

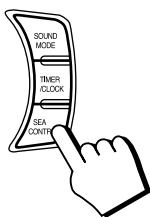

Note: If no adjustments are made for 10 seconds after SEA CONTROL is pressed, Sound Mode will appear on the display then revert to the previous display.

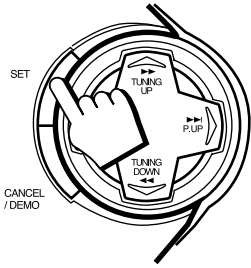
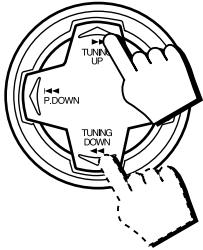
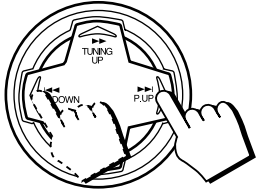

3. Use MULTI CONTROL to adjust to any Sound Mode desired.

Press ◀◀ P. DOWN or ▶▶ P. UP on the MULTI CONTROL to select the tone range you want to adjust. You can adjust “LOW”, “MID” or “HIGH” tone.

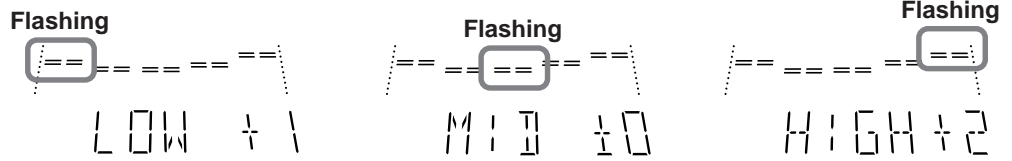

Press TUNING DOWN ◀◀ or ▶▶ TUNING UP on the MULTI CONTROL to adjust the level. The level can be adjusted between -3 and +3 in 7 steps.

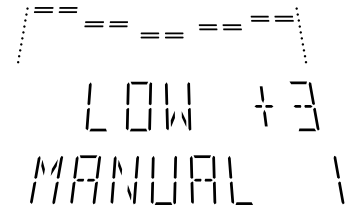

4. Press SET.

“MANUAL 1” appears on the display.

5. Press ◀◀ P. DOWN or ▶▶ P. UP on the MULTI CONTROL to select the MANUAL number for the memory.

6. Press SET again.

“MEMORY” appears for 2 seconds. The setting that has been created is stored in the memory.



- The adjustment you have made will apply to the sound you hear.
- If you store new settings to a memory number that has already been used, the new settings replace the existing setting.

When a Rear Speaker is Connected

If the optional rear speaker is connected, you can use the rear speaker to enjoy Surround effects when a Surround effect (D. CLUB, HALL, STADIUM, or a MANUAL setting based on one of these) Sound Mode is selected.

- The rear speaker cannot be used when an S.E.A. effect (ROCK, POP, CLASSIC) is selected.

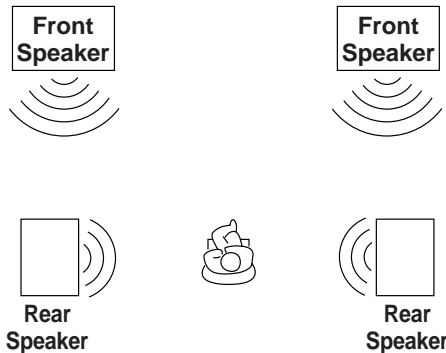

Adjusting the Rear Speaker Level

You can use the steps below to adjust the rear speaker level.

1. Select a Surround effect Sound Mode.

2. Start playback from the desired source.

3. Press SHIFT on the Remote Control.

4. Press REAR LEVEL + (8) or - (7) on the Remote Control to adjust the rear speaker level.

Each time you press the button, the level changes one step.

- You can set the level between -10 and +10 in 21 steps.
- The rear speaker level changes equally for both left and right. You cannot adjust the left and right balance for the rear speaker independently.
- You can adjust the rear speaker level for each of the Surround effect modes.

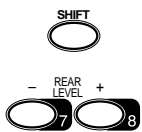

Listening to Auxiliary Equipment

By playing the sound from auxiliary equipment through the System, you can gain control over how the music or program sounds. Once the connected equipment is playing through the System, you can apply the sound effects.

■ First make sure that the auxiliary equipment is properly connected to the System. (See page 6).

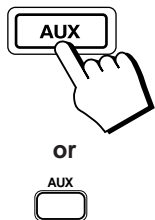

1. Turn down the volume level to 0.

2. Press AUX.

“AUX” appears on the display. The AUX button on the Unit lights up.



COMPU PLAY

When AUX is pressed while the power is on standby, the power is automatically turned on.

3. Start playing the equipment.

4. Adjust the volume level to the desired listening level.

5. Select a Sound Mode, if you wish.

To cancel the setting

Change the source by starting any one of the System's built-in sound sources, such as the Tuner or CD Player.

Dolby Surround

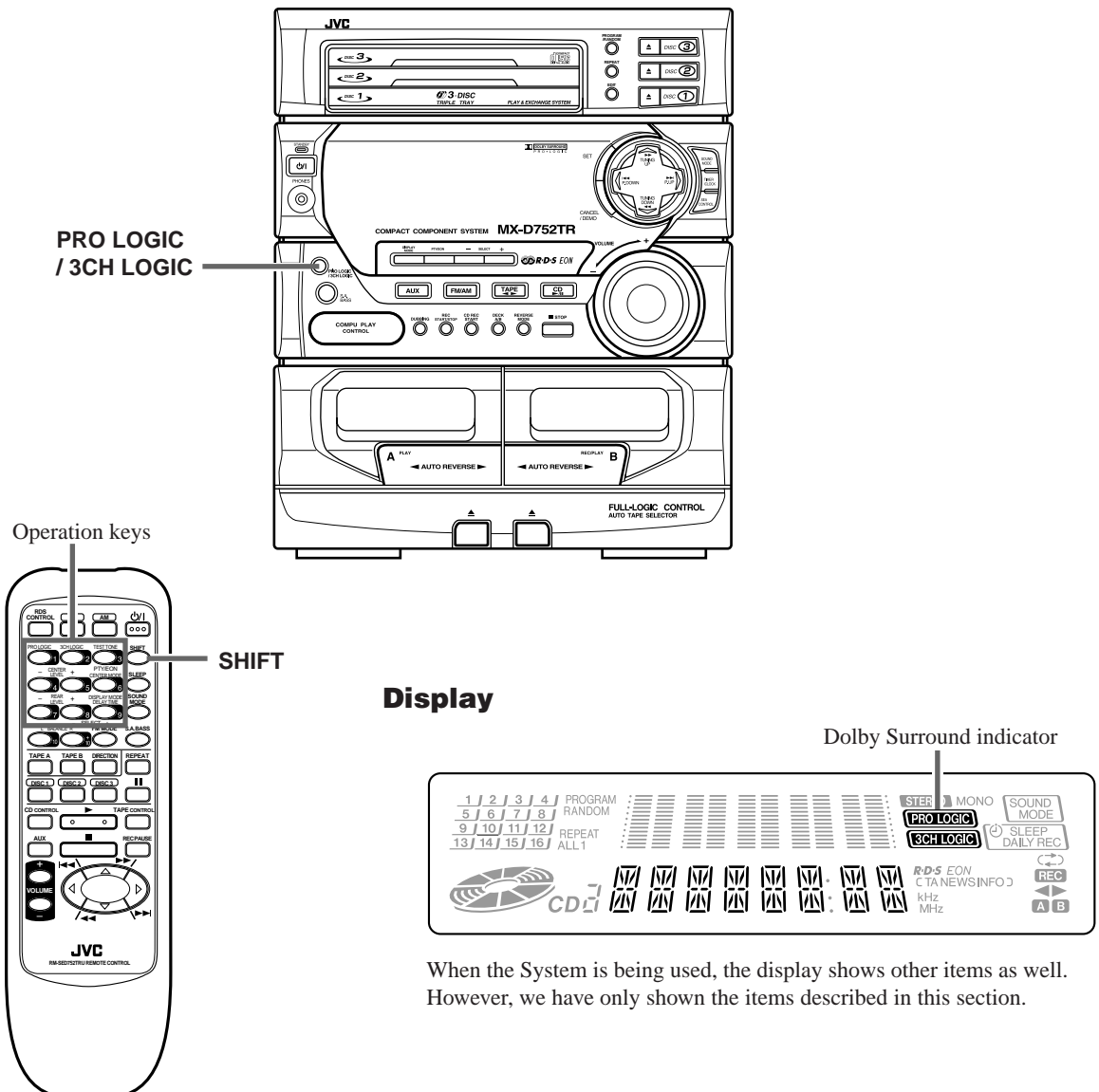

Accessing the Dolby Surround Functions

Press the operation keys with green labels on the Remote Control to use the Dolby Surround functions.

To use the function marked in green, press SHIFT first, then press the desired operation key.

The Dolby Surround has been also developed to reproduce the important elements of the acoustic surround at home. To watch the sound tracks of video software bearing the mark  which includes the same encoded surround information as found in Dolby Stereo film, the Unit can provide you with two Dolby Surround programs (Dolby Pro Logic and Dolby 3ch Logic).

Dolby Pro Logic: Select this mode when the optional rear speakers are connected.

Dolby 3ch Logic: Select this mode when no rear speakers are connected.

Manufactured under license from Dolby Laboratories Licensing Corporation. "Dolby", the double-D symbol, and "Pro Logic" are trademarks of Dolby Laboratories Licensing Corporation.

■ You need to connect the optional centre speaker and rear speakers to use the Dolby Surround functions.

Preparing the Dolby Surround

To use the Dolby Surround effects, you need to prepare the various settings. These settings are set using the Remote Control. The Dolby Surround settings are:

Centre Speaker Mode

Centre Speaker mode contains the following four settings.

- PHANTOM:** Select this setting if you have not connected a centre speaker. The left and right front speakers project the sound to give the effect of a centre speaker. (PRO LOGIC only)
- NORMAL:** Select this setting if you are using a small centre speaker. Since the centre speaker cannot boost the low tones effectively, this setting uses the front speakers to boost the low tones from the centre speaker.
- WIDE:** Select this setting if you are using a centre speaker that is similar in power to the front speakers.
- OFF:** Select this setting to turn off the output for the centre speaker.

Delay Time Mode

Delay Time mode contains the following four settings.

- DELAY 1:** Select this setting if the rear speakers are further away from your listening position than the front speakers. (Delay time: 15 msec.)
- DELAY 2:** Select this setting if the rear speakers and front speakers are about the same distance way from your listening position. (Delay time: 20 msec.)
- DELAY 3:** Select this setting if the rear speakers are nearer to your listening position than the front speakers. (Delay time: 25 msec.)
- DELAY 4:** Select this setting if the rear speakers are very close to your listening position compared to the front speakers. (Delay time: 30 msec.)

Adjusting the level of the Centre Speaker

Adjust the level of the centre speaker between +10 and -10. Set the level so that it is about the same as the level from the front speakers.

Adjusting the level of the Rear Speakers (For PRO LOGIC only)

Adjust the level of the rear speakers between +10 and -10. Set the level so that it is about the same as the level from the front speakers.

- You cannot adjust the levels of the left and right rear speakers independently.

Getting Ready To Use Dolby Pro Logic

Speaker Arrangements for Dolby Pro Logic

Layout when using the centre speaker and rear speakers

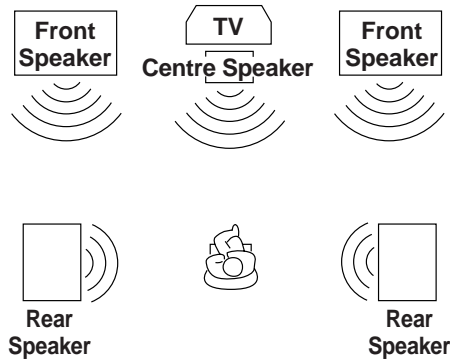

Layout when using the rear speakers

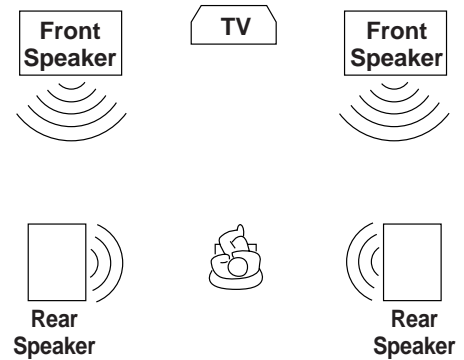

Setting-up Dolby Pro Logic



OR



1. Press PRO LOGIC/3CH LOGIC to select PRO LOGIC.

Each time you press the button, Dolby Surround programmes change as follows:
→ PRO LOGIC → 3CH LOGIC → OFF → (back to the beginning)



When using the Remote Control, press SHIFT then press 1 PRO LOGIC.

- Perform the steps below using the buttons on the Remote Control.

2. Select the desired Centre Speaker mode.

Press SHIFT on the Remote Control then press 6 CENTER MODE.

Each time you press the button, Centre Speaker modes change as follows:

→ NORMAL → WIDE → OFF → PHANTOM → (back to the beginning)

3. Select the Delay time.

Press 9 DELAY TIME. Each time you press the button, Delay time changes as follows:

→ DELAY 2 → DELAY 3 → DELAY 4 → DELAY 1 → (back to the beginning)

4. Set the volume to the level you like.

5. Press 3 TEST TONE.

A test tone comes out of the speakers in the following order:

→ LEFT → CENTER → RIGHT → REAR → (back to the beginning)

- When a test tone comes out of the rear speakers, "SURROUND" appears on the display.
- When "PHANTOM" or "OFF" is selected for Centre Speaker mode, no test tone comes out of the center speaker.

6. Adjust the level for the centre speaker.

Press CENTER LEVEL 5 + or 4 -. Set the level so that it is about the same as the level from the front speakers.



- You cannot adjust the level for the centre speaker if "PHANTOM" or "OFF" is selected for Centre Speaker mode.

7. Adjust the level for the rear speakers.

Press REAR LEVEL 8 + or 7 -. Set the level so that it is about the same as the level from the front speakers.



8. Press 3 TEST TONE again.

Test Tone mode is cancelled.

This completes the preparations required for using Dolby Pro Logic.

Getting Ready To Use Dolby 3 Channel Logic

Speaker Arrangements for Dolby 3 Channel Logic



Setting-up Dolby 3ch Logic

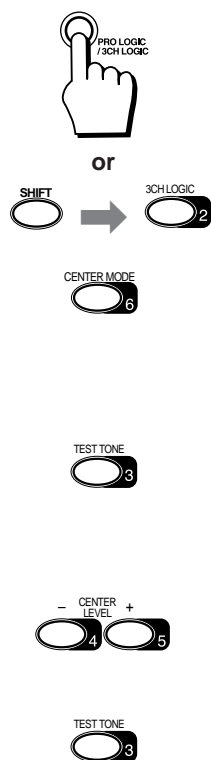

1. Press PRO LOGIC/3CH LOGIC to select 3CH LOGIC.

Each time you press the button, Dolby Surround programmes change as follows:
→ PRO LOGIC → 3CH LOGIC → OFF → (back to the beginning)

3CH LOGIC

When using the Remote Control, press SHIFT then press the 2 3CH LOGIC.

- Perform the steps below using the buttons on the Remote Control.

2. Select the desired Centre Speaker mode.

Press SHIFT on the Remote Control then press 6 CENTER MODE.

Each time you press the button, Centre Speaker modes change as follows:
→ NORMAL → WIDE → OFF → (back to the beginning)

3. Set the volume to the level you like.

4. Press 3 TEST TONE.

A test tone comes out of the speakers in the following order:

- When “OFF” is selected for Centre Speaker mode, no test tone comes out of the centre speaker.
- LEFT → CENTER → RIGHT → (back to the beginning)

5. Adjust the level for the centre speaker.

Press CENTER LEVEL 5 + or 4 -. Set the level so that it is about the same as the level from the front speakers.

CENTER ± 0

- You cannot adjust the level for the center speaker if “OFF” is selected for Center Speaker mode.

6. Press 3 TEST TONE again.

Test Tone mode is cancelled.

This completes the preparations required for using Dolby 3 Channel Logic.

- You cannot adjust the Delay Time or rear speaker levels in Dolby 3 Channel Logic mode.

Using Dolby Surround

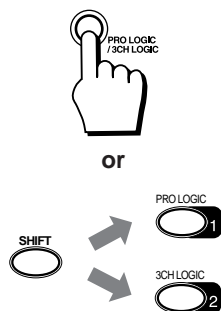

1. Press PRO LOGIC/3CH LOGIC and select the desired mode.

If you are using the Remote Control, press 1 PRO LOGIC or 2 3CH LOGIC after pressing SHIFT. Make sure that the center speaker and rear speakers have been set up correctly, as described on pages 15 to 17.

2. Playback as source with the [DOLBY SURROUND] mark.

Enjoy the great sound achieved through Dolby Surround.

To Cancel Dolby Surround Effects

Press PRO LOGIC/3CH LOGIC until the Dolby Surround indicator goes out. If you are using the Remote Control, press the Dolby Surround buttons (1 PRO LOGIC or 2 3CH LOGIC) after pressing SHIFT.

Using the Tuner

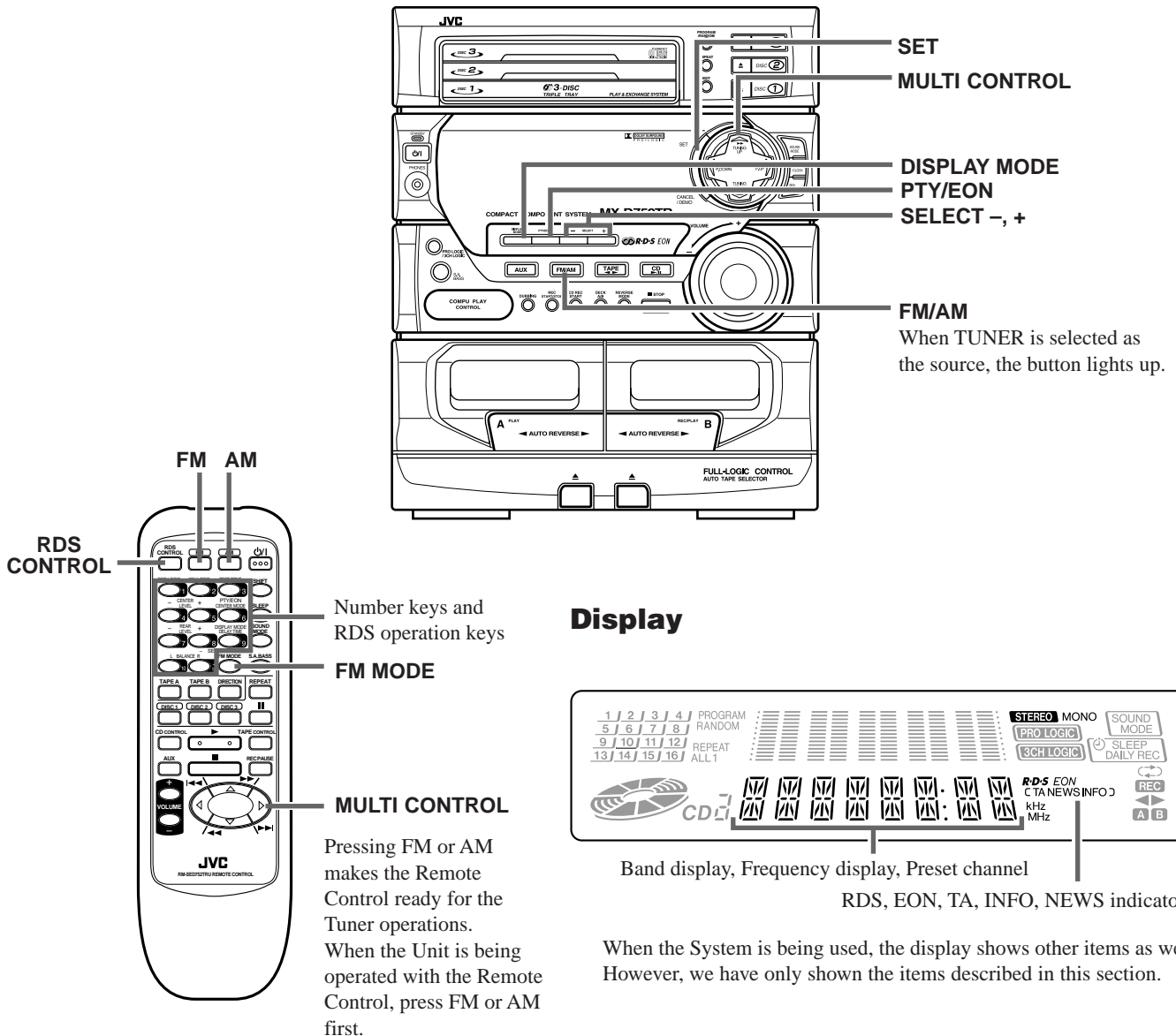

You can listen to both FM and AM (MW/LW) stations. Stations can be tuned in manually, automatically, or from preset memory storage.

■ Before listening to the radio:

- Check that both the FM and AM antennas are firmly connected. (See page 4.)

Tuning in a Station

Press FM/AM on the Unit (or FM or AM on the Remote Control) to turn on the radio.

The frequency of the previously selected channel appears on the display.

Switching between Frequency Bands

On the Unit

Press FM/AM.

Each time you press the button, the band alternates between FM and AM (MW/LW).

COMPU PLAY

When FM/AM is pressed while the power is on standby, the power is automatically turned on.



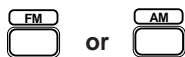

On the Remote Control
To tune in FM stations, press FM.
To tune in AM stations, press AM.

COMPU PLAY

When FM or AM is pressed while the power is on standby, the power is automatically turned on.

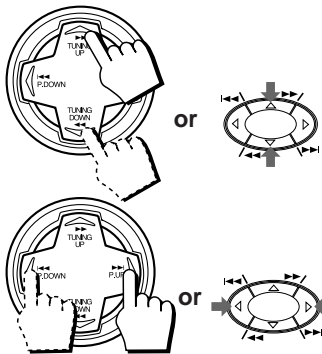

Three Ways to Select a Station

- Press TUNING DOWN ◀◀ or ▶▶ TUNING UP on the MULTI CONTROL repeatedly to move from frequency to frequency until you find the one you want. (Manual Tuning).
OR
- Press and hold TUNING DOWN ◀◀ or ▶▶ TUNING UP on the MULTI CONTROL for a few seconds, the frequency starts changing on the display. When a station is tuned in, the frequency stops changing. (Auto Tuning).

OR

- Possible only after presetting stations.
Press once and release ◀◀ P. DOWN or ▶▶ P. UP on the MULTI CONTROL to go to the next preset station.

You can also use the Remote Control to tune in preset channels:

1. Press FM or AM so that you can receive the last station tuned in.
2. Select the station by entering the preset number in the number keys of the Remote Control.
 - Example: for channel 5, press 5. For channel 15, press +10 then 5.
 - For channel 20, press +10, then 10. For channel 30, press +10 twice then 10.



- After you have selected the preset number and the number appears, the broadcast frequency of the selected channel appears on the display.

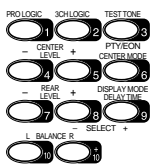

Presetting Stations



You can preset up to 30 FM stations and up to 15 AM (MW/LW) stations for the preset numbers.

Note: In some cases, test frequencies have been already memorized for the tuner since the factory examined the tuner preset function before shipment. This is not a malfunction. You can preset the stations you want into memory by following the presetting method.

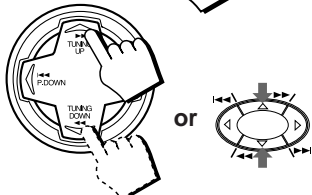

1. **Select a band by pressing FM/AM on the Unit.**

When using the Remote Control, press FM or AM.

2. **Press TUNING DOWN ◀◀ or ▶▶ TUNING UP on the MULTI CONTROL to tune into a station.**

3. **Press SET.**

“SET” flashes for 5 seconds.

While it is still flashing, carry out the following procedure.

SET

4. **Press ◀◀ P. DOWN or ▶▶ P. UP on the MULTI CONTROL on the Unit to set the preset number.**

P 5

5. **Press SET again.**

“STORED” appears for 2 seconds. The preset station is stored in the memory.

STORED

6. **Repeat steps 1 to 5 for each station you want to store in memory using different preset numbers.**

CAUTION: If the Unit is unplugged or if a power failure occurs, the preset stations will be erased in a few days. If this happens, preset the station again.

Changing the FM Reception Mode

When an FM stereo broadcast is hard to receive or noisy, press FM MODE on the Remote Control so that the MONO indicator lights up on the display. Reception improves, but there is no stereo effect.



To restore the stereo effect, press FM MODE on the Remote Control so that the MONO indicator goes out. In this stereo mode, the STEREO indicator lights up and you can hear stereo effects, when a program is broadcast in stereo.



Receiving FM Stations with RDS

RDS (Radio Data System) allows the FM stations to send additional signals along with their regular programme signals. For example, the stations send their station names and information about what type of programme they broadcast, such as sports or music, etc.

When tuned to an FM station which provides the RDS service, the station frequency (and then the station name if sent) is displayed.

One convenient RDS service is “Enhanced Other Networks (EON)”. This allows the Unit to automatically switch to a programme type of your choice when one starts in your broadcast area.

- Not all FM stations provide RDS service, nor do all RDS stations provide the same services. If in doubt, check with local radio stations for details on RDS services in your area.
- RDS may not work correctly if the station to which you are tuned is not transmitting properly or if the signal strength is weak.

What Information RDS can Provide

The System can use the following RDS service.

PS (Programme Service name)

Identifies each station by a name.

TA (Traffic Announcement Identification)

Identifies that a traffic announcement is being broadcast in your area.

RT (Radio Text)

Allows the RDS station to send text messages that appear on the display of the unit.

PTY (Programme Type)

Identifies the type of RDS programme. This allows you to locate a specific type of programme being broadcast.

The programme types are as follows:

NEWS	AFFAIRS	INFO	SPORT	EDUCATE
DRAMA	CULTURE	SCIENCE	VARIED	POP M
ROCK M	M.O.R. M	LIGHT M	CLASSICS	OTHER M
WEATHER	FINANCE	CHILDREN	SOCIAL A	RELIGION
PHONE IN	TRAVEL	LEISURE	JAZZ	COUNTRY
NATIONAL	OLDIES	FOLK M	DOCUMENT	TRAFFIC

ALARM

EON (Enhanced Other Networks)

Provides information available on RDS stations other than the one which is being received.

Changing the Display

You can see RDS information on the display while listening to a FM station.

To view RDS information on the display, press DISPLAY MODE. (When using the Remote Control, press 6 DISPLAY MODE after pressing RDS CONTROL).

Each time you press the button, the display changes to show the following information:

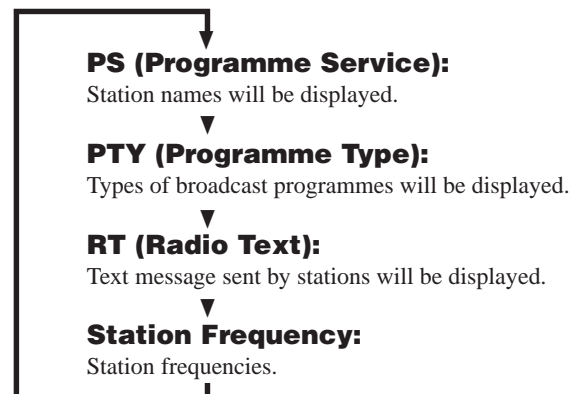
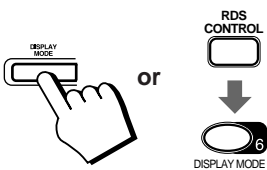

- While RDS information is being received from a station, “PS”, “PTY”, or “RT” may appear on the display.

Searching for Programmes by PTY codes

One of the advantages of the RDS service is that you can locate a particular kind of programme by specifying the PTY codes.

■ The PTY Search function is applicable to preset stations only.

To search for a programme using the PTY codes, follow this procedure:

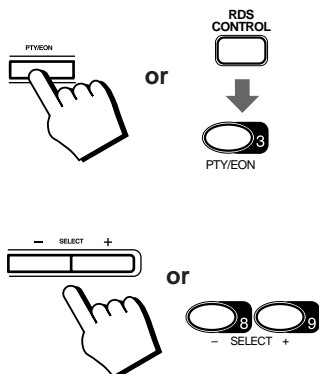

1. Press PTY/EON once.

- When using the Remote Control, press 3 PTY/EON after pressing RDS CONTROL. “PTY” and “SELECT” appear alternately on the display.

Note: If no adjustments are made for 10 seconds in PTY Select mode, the display reverts to the previous display. Perform the next step while “PTY” and “SELECT” are being displayed.

2. Press SELECT + or SELECT - to select a PTY.

- When using the Remote Control, press 8 SELECT - or 9 SELECT +.

Each time you press the button, PTY codes change as follows:

SELECT + →
 ↔ NEWS ↔ AFFAIRS ↔ INFO ↔ SPORT ↔ EDUCATE ↔ DRAMA ↔
 CULTURE ↔ SCIENCE ↔ VARIED ↔ POP M ↔ ROCK M ↔ M.O.R. M ↔
 LIGHT M ↔ CLASSICS ↔ OTHER M ↔ WEATHER ↔ FINANCE ↔
 CHILDREN ↔ SOCIAL A ↔ RELIGION ↔ PHONE IN ↔ TRAVEL ↔
 LEISURE ↔ JAZZ ↔ COUNTRY ↔ NATIONAL ↔ OLDIES ↔ FOLK M ↔
 DOCUMENT ↔ TRAFFIC ↔
 ← SELECT -

3. Press PTY/EON again.

- When using the Remote Control, press 3 PTY/EON.

While the search function is running, the selected programme type and “SEARCH” alternate on the display.

Once the station which is broadcasting the selected PTY (Programme Type) is located, searching will stop. Then the station name (if PS code is being sent) will be indicated and the broadcast will commence. The indication will stay flashing for 10 seconds from the end of the searching function. If you press PTY/EON again during this period, search for the same PTY (Programme Type) will restart.

■ If a station broadcasting a selected PTY (Programme Type) cannot be found, “NOTFOUND” appears on the display after the Unit has searched through the preset numbers. The Unit will return to the station to which it was tuned prior to the start of the PTY Search.

To cancel a PTY Search operation, press PTY/EON. (When using the Remote Control, press 3 PTY/EON.)

EON Function

With the EON (Enhanced Other Networks) code, the Unit can perform a stand-by reception which will enable you to obtain desired information which is available from other stations.

- “EON” will be shown while receiving stations with an EON code.
- EON Stand-by reception is applicable for preset stations only.
- You can set EON Stand-by reception regardless of types of receiving bands.

Setting EON Stand-by reception

1. Press PTY/EON twice.

- When using the Remote Control, press 3 PTY/EON after pressing RDS CONTROL. The last EON information type selected is displayed.

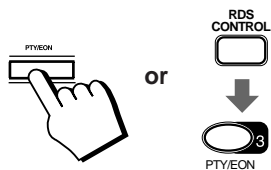

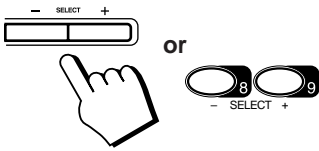

2. Select information you want by pressing SELECT + or SELECT -.

- When using the Remote Control, press the 9 SELECT + or 8 SELECT - button.

TA: Identifies that a traffic announcement is being broadcast in your area.

NEWS: News

INFO: Programmes on medical service, weather forecast, etc.

- Each time you press the button, EON codes change as follows:

SELECT + →
 ↔ TA ↔ NEWS ↔ INFO ↔ OFF ↔
 ← SELECT -

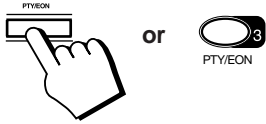

3. Press PTY/EON.

- When using the Remote Control, press 3 PTY/EON.

As soon as your selection is entered, the Unit will go into EON Stand-by reception mode.

To cancel the EON function, select "OFF" by following the steps above.

When this Unit carries out EON Stand-by reception, the indication will change as follows:

- Waiting for EON Stand-by reception.

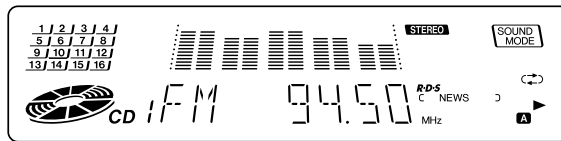

- Preset stations are being searched for and while preparing to change the station, sound will be muted.

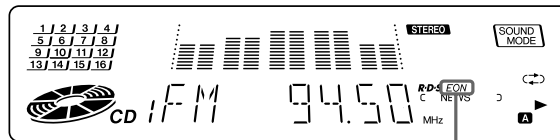

Light up

- The station will be changed and the Station name being received will appear on the display.



Flashing

- To view the other RDS information on the display, press DISPLAY MODE. (When using the Remote Control, press 6 DISPLAY MODE after pressing RDS CONTROL).

Notes:

- EON broadcasts of some stations may not be compatible with this Unit. In the case of an incompatible EON broadcast, "EON" will not appear on the display.
- If the reception is unsatisfactory for a station among the preset stations, the station is searched for again. If after searching through the channels, the broadcasting station cannot be found, "NOTFOUND" appears on the display. The Unit will return to the station to which it was previously tuned.

When broadcasting of the desired information has been completed, the Unit will automatically go back to the station which had previously been tuned to.

- While receiving information on EON Standby reception, the station will not change to other stations even if the same information is available from them.
- If the information you are waiting for is available from the current station, the indicator will flash.

ALARM function

If an ALARM (Emergency) signal is received while receiving an EON code from a station, the Unit automatically switches to the station broadcasting the ALARM signal.

Using the CD Player

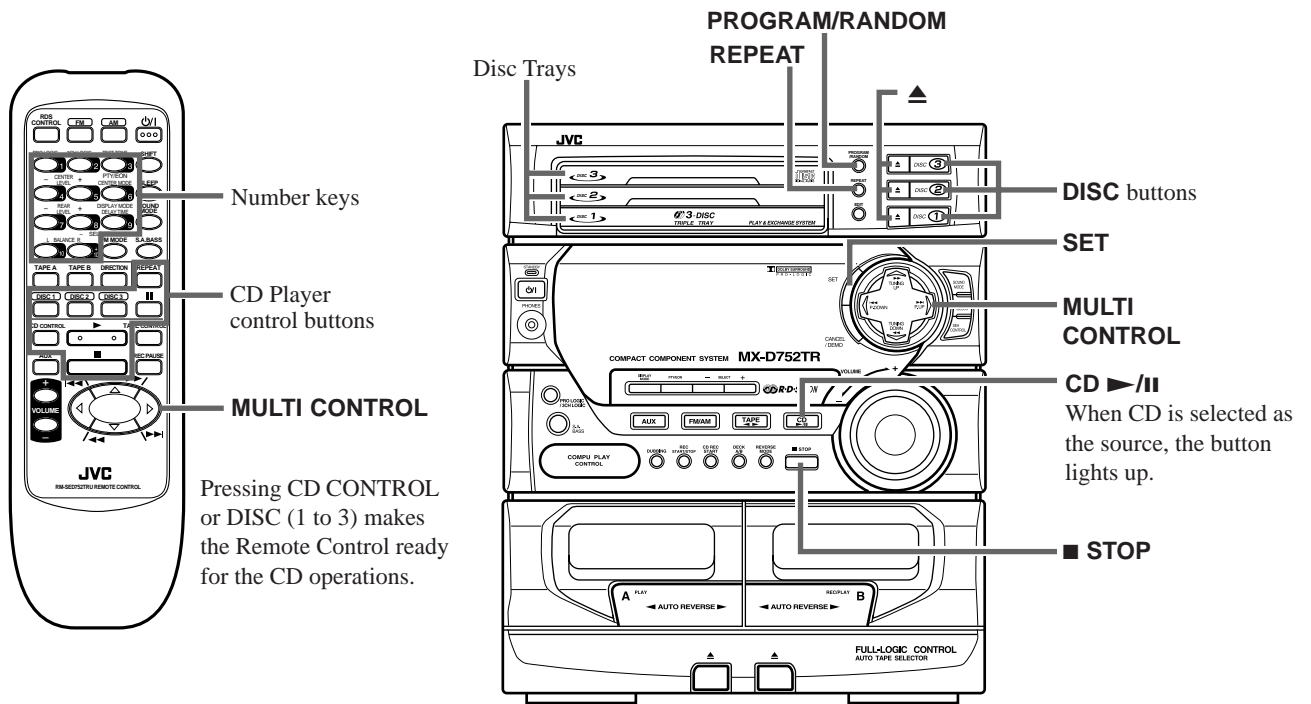

Display

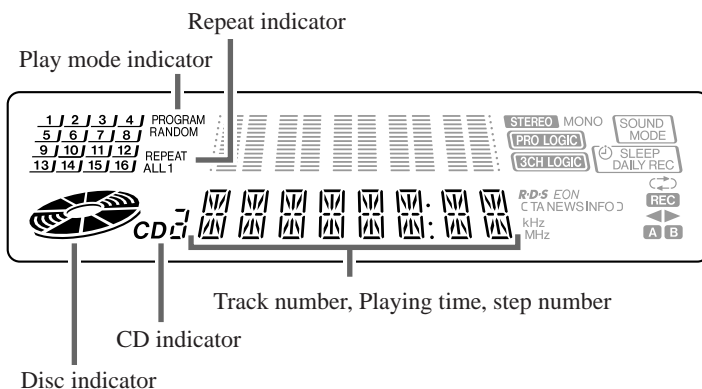

Disc indicator

Flashes while a CD is playing.
Is lit when a CD has stopped or is paused.

CD indicator

Indicates the number of the disc selected.

When the System is being used, the display shows other items as well. However, we have only shown the items described in this section.

The System's CD Player has an Automatic Changer with 3 disc trays. You can use Continuous, Random, Program or Repeat Play for the discs in DISC 1, DISC 2 and DISC 3. Repeat Play can repeat all the tracks on all the CD's or one track on one CD. There is also the Tray Lock function, which safely keeps discs in the trays.

Here are the basic things you need to know to play a CD and locate the different selections on it. Each selection is called a track, so when we are talking about locating a track, we are also talking about how you find a certain song or performance.

Entering CD Operation Mode with the Remote Control

Pressing CD CONTROL or DISC (1 to 3) makes the Remote Control ready for the CD operations. Operate the CD player with ►, ■, MULTI CONTROL, and number keys.

The explanation provided in this section assumes that the Remote Control has been put into CD operation mode. When you use the Remote Control, press CD CONTROL first.

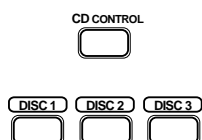

Loading CDs

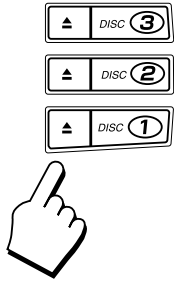

1. Press **▲** on the CD Player you want to insert the disc onto.

“OPEN” appears on the display and the disc tray slides out.

OPEN

COMPU PLAY

When **▲** is pressed while the power is on standby, the power is automatically turned on.

2. Place a CD, with its label side up, onto the tray.

ATTENTION: To avoid malfunctions when you play a CD, set the CD in the right place at the center of the tray.

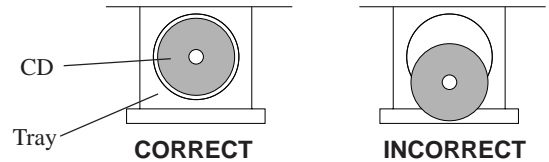

3. Press **▲** to close the tray.

“CLOSE” appears on the display.

CLOSE

4. Repeat steps 1 to 3 to insert other discs onto the other trays.

- To continue putting discs onto other trays, even if a tray is open, by pressing the **▲** button of another disc tray, the open tray will close automatically, and the new disc tray will slide out.

- When you place a CD onto the currently selected tray, whose disc number shown on the CD indicator, reading of the CD starts. The total number of tracks and total playing time appear after the reading is completed, then the playing time of the first track appears.

1150 -- 1 → /4 67:44 → / 5:40

Reading now (flashing) Total number of tracks and playing time Playing time of the 1st track

- To put an 8 cm CD onto a tray, insert it so that it is aligned with the groove in the tray's center.
- If a tray is open when the System switches to the standby mode, the tray will close automatically.

Basics of Using the CD Player — Continuous Play

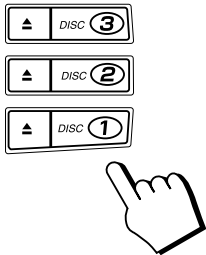

Playing a CD

Prepare the CDs.

On the Unit

Press **CD ▶/||**.

The source is set to CD and play starts from the first track of the currently selected CD whose disc number shown on the CD indicator.

Press **DISC (1 to 3)** of the disc you want to play.

The source is set to CD and play starts from the first track of the selected CD.

COMPU PLAY

When **CD ▶/||** or **DISC (1 to 3)** is pressed while the power is on standby, the power is automatically turned on.

- When you press **CD ▶/||** or **DISC (1 to 3)** while the disc tray is open, the tray will automatically close before beginning to play.
- If there is no CD in the disc tray, “NO DISC” appears on the display.

Playing order of discs

- When playback starts from **DISC 1**, the playing order is **DISC 1 → DISC 2 → DISC 3**. When **DISC 3** has finished, the CD Player stops.
- When playback starts from **DISC 2**, the playing order is **DISC 2 → DISC 3 → DISC 1**. When **DISC 1** has finished, the CD Player stops.
- When playback starts from **DISC 3**, the playing order is **DISC 3 → DISC 1 → DISC 2**. When **DISC 2** has finished, the CD Player stops.
 - If any of the disc trays are empty, the CD Player skips that disc tray and continues through the remaining disc trays in the order shown above. When the last disc has finished playing, the Unit will stop automatically.



On the Remote Control

Press CD CONTROL then press ►.

The source is set to CD and play starts from the first track of the currently selected CD whose disc number shown on the CD indicator.

- If the above operation is carried out while the power is on standby, the power is automatically turned on.



Press DISC (1 to 3) of the disc you want to play.

The source is set to CD and play starts from the first track of the selected CD.

COMPU PLAY

When DISC (1 to 3) on the Remote Control is pressed while the power is on standby, the power is automatically turned on.

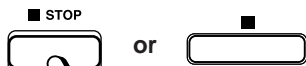

To stop playing the disc, press ■ STOP (or ■ on the Remote Control). The display will show the total number of tracks and total playing time of the disc that was playing followed by the playing time of the first track.

To stop play and remove the disc, press ▲ for the disc being played.

To pause, press CD ►/|| (or || on the Remote Control). The playing time will flash.

To cancel pause, press CD ►/|| (or ► on the Remote Control). Play continues from the point where it was paused.

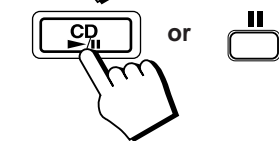

Selecting a Track

Press ◀◀ P. DOWN or ▶▶ P. UP on the MULTI CONTROL to select the track.

The selected track starts playing.

- Each time you press ◀◀ P. DOWN or ▶▶ P. UP, the track changes by one.

Press and hold ◀◀ P. DOWN or ▶▶ P. UP to continuously change tracks.

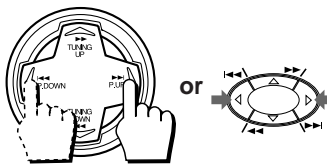

Locating a Track with the Remote Control Directly

Using the number keys on the Remote Control allows you to go directly to the beginning of any track.



1. Press the DISC (1 to 3) for the disc tray containing the track you want to listen to.

- Example: for the third disc, press DISC 3.

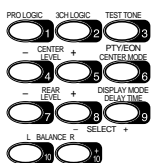

2. Enter the number of the track you want to listen to with the number keys.

The selected track starts playing.

- Example: for track 5, press 5. For track 15, press +10 then 5. For track 20, press +10, then 10. For track 32, press +10 three times, then 2.

Fast Forward / Reverse

Use TUNING DOWN ◀◀ or ▶▶ TUNING UP on the MULTI CONTROL.

For Fast Forward, press and hold down ▶▶ TUNING UP. For Reverse, press and hold down TUNING DOWN ◀◀. Release the button when the part you wish to listen to is reached.

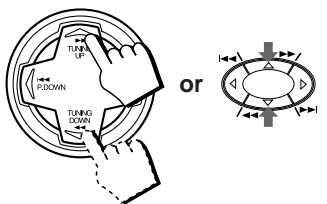

Changing Discs While Playing

You can replace a CD in a tray not being used, while another CD is playing.

1. Press ▲ of the tray not being used.

The tray opens.

2. Replace the disc in the tray.

3. Press ▲ to close the tray.

Programming the Playing Order of the Tracks

You can change the order in which the discs and tracks play, and select only the discs and tracks you want from among those loaded in the CD Player.

- You can programme up to 32 steps in any desired order from among the discs in the CD player.
- You can only programme the CD Player when it is stopped.

On the Unit

1. Press PROGRAM/RANDOM.

“PROGRAM” appears on the display and the PROGRAM indicator lights up.

PROGRAM

If you have already created a programme, the last step of the previous programme will appear on the display.

Each time you press the button, play mode changes as follows:

→ PROGRAM → RANDOM → No Play mode indicator (Continuous Play) → (back to the beginning)

2. Select a disc with DISC (1 to 3).

The display changes to the Programme Entry display and the disc number and track number flash for a few seconds.

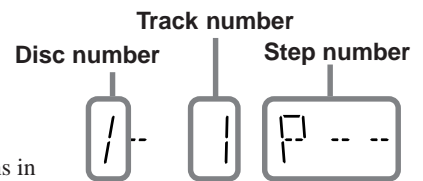

- While the indications are flashing, perform the operations in steps 3 to 4. When the flashing indications change to “PROGRAM”, repeat the operations in steps 2 to 4.

3. Press ◀◀ P. DOWN or ▶▶ P. UP on the MULTI CONTROL to select a track for programming.

The disc number and track number starts flashing on the display.

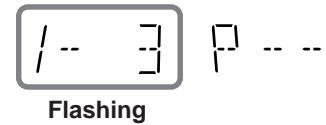

4. Press SET.

The indications on the display stop flashing and remains lit. The step number appears on the display.



5. Repeat steps 2 to 4 to select the other tracks for the programme.

To select another track from the same disc, repeat the procedure from step 3.

6. Press CD ▶/II.

The Unit plays the tracks in the order you have programmed them.

On the Remote Control

1. Press PROGRAM/RANDOM on the Unit.

“PROGRAM” appears on the display and the PROGRAM indicator lights up.

PROGRAM

If you have already created a programme, the last step of the previous programme will appear on the display unless you have erased the programme.

Each time you press the button, play mode changes as follows:

→ PROGRAM → RANDOM → No Play mode indicator (Continuous Play) → (back to the beginning)

2. Select a disc with DISC (1 to 3).

The display changes to the Programme Entry display and the disc number and track number flash for a few seconds.

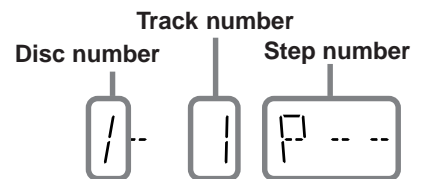

- While the indications are flashing, perform the operation in step 3. When the flashing indications change to “PROGRAM”, repeat the operations in steps 2 to 3.

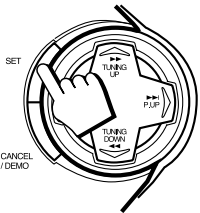
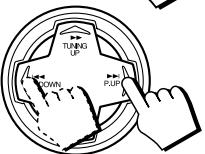

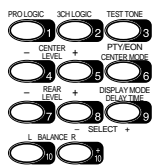

3. Press the number keys (1 to 10 and +10) to select the tracks.

The indications on the display stop flashing and remains lit.

The selected track numbers light up and the step number appears on the display.

- Example: For track 5, press 5.

For track 15, press +10 then 5.

For track 20, press +10 then 10.

For track 32, press +10 three times, then 2.



4. Repeat steps 2 to 3 to select the other tracks for the programme.

5. Press ►.

The Unit plays the tracks in the order you have programmed them.

- If you try to programme a 33rd track, "FULL" will appear on the display to let you know that the programme is full.
- If you try to programme a disc tray that is empty, or a track number that does not exist on a disc (for example, selecting track 14 on a disc that only has 12 tracks), the selected disc or track are skipped when the programme is played.
- You can skip to a particular programme step by pressing the MULTI CONTROL (◀◀ P. DOWN or ▶▶ P. UP) or ◀◀ or ▶▶ on the Remote Control during programme play.
- To play the programmed tracks repeatedly, press REPEAT. For details, refer to "Repeating a Track or the Discs" on page 28.

To stop playing, press ■ STOP (or ■ on the Remote Control) once.

To delete all the tracks in a programme, press ■ STOP (or ■ on the Remote Control) while the CD Player is stopped. The programme is deleted and "PROGRAM" appears on the display.

To cancel programme play, press ■ STOP (or ■ on the Remote Control) while "PROGRAM" is shown on the display.

Checking the Programme

While the CD Player is stopped, use ◀◀ or ▶▶ on the Remote Control to check the contents of the programme.

Each time you press ▶▶, the programme contents are shown on the display in the programmed order.

Pressing ◀◀ displays the previous step in the programme.

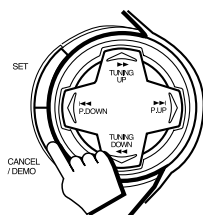
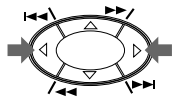

Changing the Programme

Modify the contents of a programme while the CD Player is stopped.

Press CANCEL/DEMO on the Unit, the last step in the programme is deleted.

Each time you press the button, the last step listed in the programme is deleted from the programme.

To add a step to the programme, follow the procedure above (on either the Unit or the Remote Control).

The new steps are added to the end of the programme.

Random Play

The tracks of all loaded CDs will play at random.

1. Press PROGRAM/RANDOM while the CD Player is stopped to change to the Random Mode display.



Each time you press the button, play mode changes as follows:

→ PROGRAM → RANDOM → No Play mode indicator (Continuous Play) → (back to the beginning)

2. Press CD ►/II.

The tracks of all the CDs are played in random order.

When all of the tracks have been played, the CD Player stops.

Note: Random Play cannot be activated with the DISC buttons and the number keys.

- You can skip to the next track by pressing ▶▶ P. UP on the MULTI CONTROL (or ▶▶ on the Remote Control) during Random Play. Each time you press the button, the next track is jumped to. (You cannot skip to the previous tracks, nor to the beginning of the current track during Random Play.)
- To continue with a different random track selection after the last track is played, press REPEAT to select REPEAT ALL before or during Random Play.

To cancel Random Play, press ■ STOP (or ■ on the Remote Control) twice. When the RANDOM indicator goes out, Continuous Play mode is resumed.



Repeating a Track or the Discs

You can have all the discs, the program or the individual track currently playing repeat as many times as you like.



Press REPEAT on the Unit.

Each time you press the button, the Repeat Modes change as follows.

→ REPEAT ALL → REPEAT 1 → No indicator → (back to the beginning)

REPEAT ALL: Repeats all the tracks on the CDs, or all the tracks in the program.

REPEAT 1: Repeats one track on one CD.

To exit Repeat Mode, press REPEAT until the Repeat Mode indicator on the display goes out.

Tray Lock Function

In order to safely keep the discs in the CD Player, the three trays can be electronically locked in a single operation.

When the Tray Lock function is on, the trays cannot be opened even if the ▲ button is pressed.

This function can only be accessed by using the buttons on the Unit itself.

Locking the Trays

1. Put the System's power into STANDBY mode.

2. While pressing ■ STOP, press ▲ for DISC 1 on the Unit.

"LOCKED" appears on the display to let you know that the trays have been locked.

LOCKED

When the CD Player trays are locked, pressing ▲ displays the message "LOCKED" on the display and the trays do not open. Also, ▲ cannot be used to automatically turn on the power.

Unlocking the Trays

1. Put the System's power into STANDBY mode.

2. While pressing ■ STOP, press ▲ for DISC 1 on the Unit.

When the unlock operation is done, "UNLOCKED" appears on the display to show that the lock has been taken off.

UNLOCKED

The trays can now be opened by pressing ▲.

▲ can also be used to automatically turn on the power.

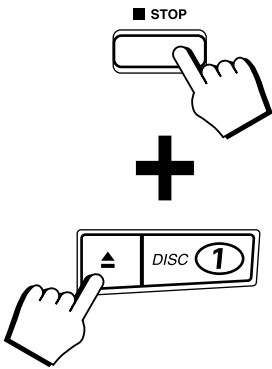

Using the Cassette Deck (Playing)

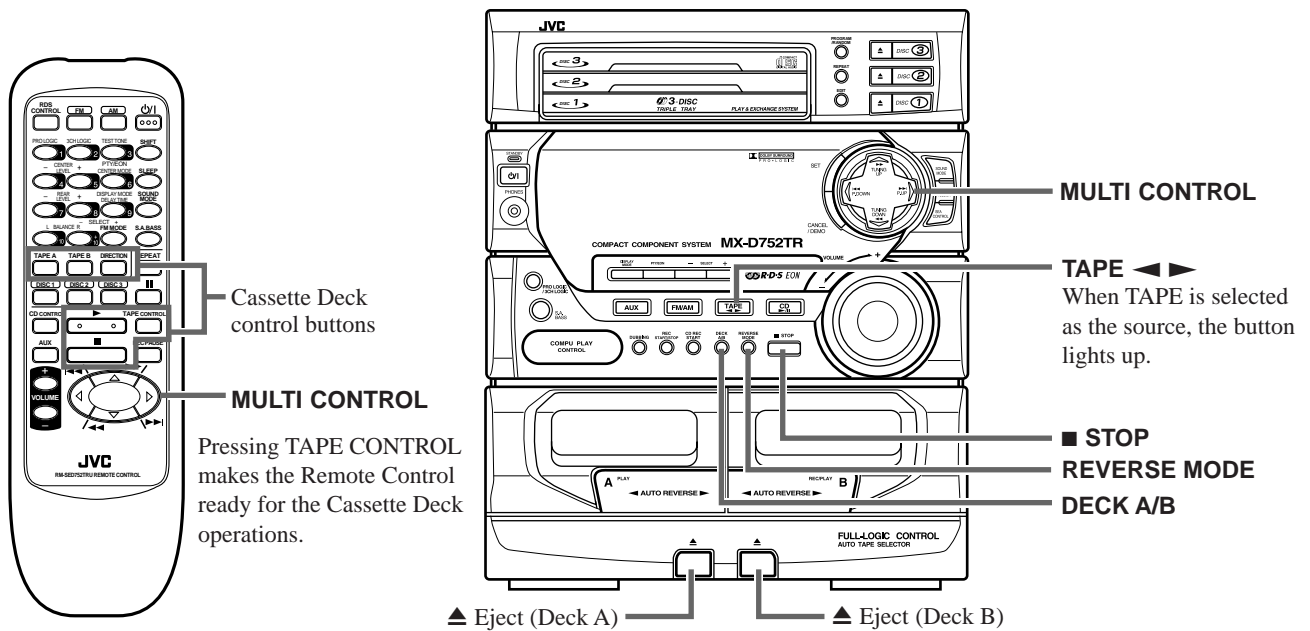

Display

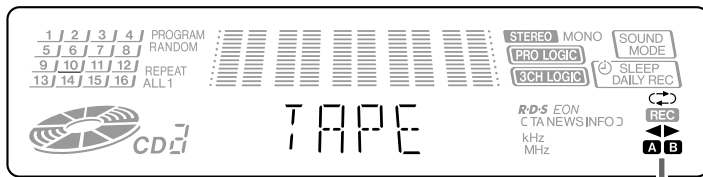

When the System is being used, the display shows other items as well. However, we have only shown the items described in this section.

Tape Direction Indicator on the Display

The Tape Direction indicator tells you which direction the selected tape deck will use for playback. During playback, the direction indicator flashes slowly. During fast left or fast right, the indicator flashes quickly. During Music Scan mode, the indicator flashes slowly and quickly alternately.

- : Reverse Mode indicator
- : Tape Direction indicator
- : DECK A, B indicator

The Cassette Deck allows you to play, record and dub audio tapes.

■ With Automatic Tape Detection, you can listen to Type I or II tapes without changing any settings.

The use of tapes longer than 120 minutes is not recommended, since characteristic deterioration may occur and these tapes easily jam in the pinch-rollers and the capstans.

Entering the TAPE Operation Mode with the Remote Control

Pressing TAPE CONTROL makes the Remote Control ready for the Cassette Deck operations.

Operate the Cassette Deck with , and MULTI CONTROL.

The explanation provided in "Using the Cassette Deck" section assumes that the Remote Control has been put into Cassette Deck operation mode. When you use the Remote Control, press TAPE CONTROL first.



Regular Play

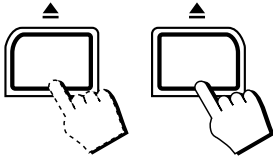

When the power is already on, you can use this basic procedure:

- 1. Press down \blacktriangle for the deck you want to use.**
- 2. When the cassette holder opens, put a cassette in, with the exposed part of the tape down, toward the base of the Unit.**
 - If the cassette holder does not open, turn the power off, then back on and press down \blacktriangle again.
- 3. Close the holder gently.**

When both Deck A and Deck B contain a tape, the last deck to have a tape inserted is selected.
To change the selected deck, press DECK A/B. When using the Remote Control, press TAPE A or TAPE B.
- 4. Press TAPE $\blacktriangleleft \blacktriangleright$ on the Unit.**



COMPU PLAY

When the TAPE $\blacktriangleleft \blacktriangleright$ is pressed while the power is on standby, the power is automatically turned on.

When using the Remote Control, first press TAPE CONTROL followed by \blacktriangleright .

If the power is on standby, the power will automatically be turned on.

When "TAPE" appears on the display, the tape play starts toward the direction currently selected.

To stop playing, press \blacksquare STOP on the Unit (or \blacksquare on the Remote Control).

To remove the tape, stop the tape, and press down \blacktriangle .

To change deck while playing a tape, press TAPE $\blacktriangleleft \blacktriangleright$ after pressing DECK A/B on the Unit or press \blacktriangleright after pressing TAPE A or TAPE B on the Remote Control.

To change the direction of a tape while it is playing, press TAPE $\blacktriangleleft \blacktriangleright$ on the Unit or DIRECTION on the Remote Control.

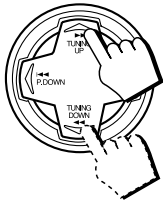

Fast Left and Fast Right

\blacksquare While the tape is stopped, press TUNING DOWN $\blacktriangleleft \blacktriangleright$ on the MULTI CONTROL (or $\blacktriangleleft \blacktriangleright$ on the Remote Control) and the tape will wind rapidly to the left side of the cassette without playing.

\blacksquare While the tape is stopped, press $\blacktriangleright \blacktriangleright$ TUNING UP on the MULTI CONTROL (or $\blacktriangleright \blacktriangleright$ on the Remote Control) and the tape will wind rapidly to the right side of the cassette without playing.

Note: Deck A and Deck B cannot be used for playback at the same time.

Music Scan

To find the beginning of a music track during play, use the Music Scan function. Music Scan searches for blank portions that usually separate selections, then plays the next selection.

Finding the Beginning of the Current Selection

Press TUNING DOWN $\blacktriangleleft \blacktriangleright$ or $\blacktriangleright \blacktriangleright$ TUNING UP on the MULTI CONTROL (or $\blacktriangleleft \blacktriangleright$ or $\blacktriangleright \blacktriangleright$ on the Remote Control) during play.

\blacksquare Make sure that you press TUNING DOWN $\blacktriangleleft \blacktriangleright$ or $\blacktriangleright \blacktriangleright$ TUNING UP on the MULTI CONTROL (or $\blacktriangleleft \blacktriangleright$ or $\blacktriangleright \blacktriangleright$ on the Remote Control) in the opposite direction to that in which the tape is playing. Searching stops at the beginning of the current selection, and the current selection starts automatically.

Finding the Beginning of the Next Selection

Press TUNING DOWN $\blacktriangleleft \blacktriangleright$ or $\blacktriangleright \blacktriangleright$ TUNING UP on the MULTI CONTROL (or $\blacktriangleleft \blacktriangleright$ or $\blacktriangleright \blacktriangleright$ on the Remote Control) during play.

\blacksquare Make sure that you press TUNING DOWN $\blacktriangleleft \blacktriangleright$ or $\blacktriangleright \blacktriangleright$ TUNING UP on the MULTI CONTROL (or $\blacktriangleleft \blacktriangleright$ or $\blacktriangleright \blacktriangleright$ on the Remote Control) in the same direction as that in which the tape is playing. Searching stops at the beginning of the next selection, and the next selection starts automatically.

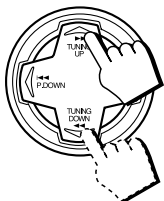

or

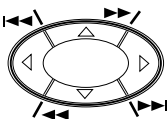

Music Scan works by detecting a 4-second long blank at the beginning of each selection, so it will not work well if your tape has . . .

- No blank at the beginning of a selection.
- Noise (often caused by much use or poor quality dubbing) which fills the blank with noise.
- Long, very soft passages or pauses in a selection. The scan will detect these as 4-second long blanks. If this happens, just scan again until you reach the selection you want.

Reverse Mode



- Use **Reverse Mode** to make the tape automatically reverse at the end of a side and start playing the other side.

Each time you press REVERSE MODE, the Reverse Mode turns on and off alternately.

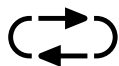

Reverse Mode ON



Reverse Mode OFF

- **Continuous Play:** With the Reverse Mode indicator on, when tape playback in the reverse (◀) direction finishes, the Unit always checks to see if a tape is in the other deck. If there is, it automatically starts playing. This Continuous Play function works regardless of which deck starts first.

Using the Cassette Deck (Recording)

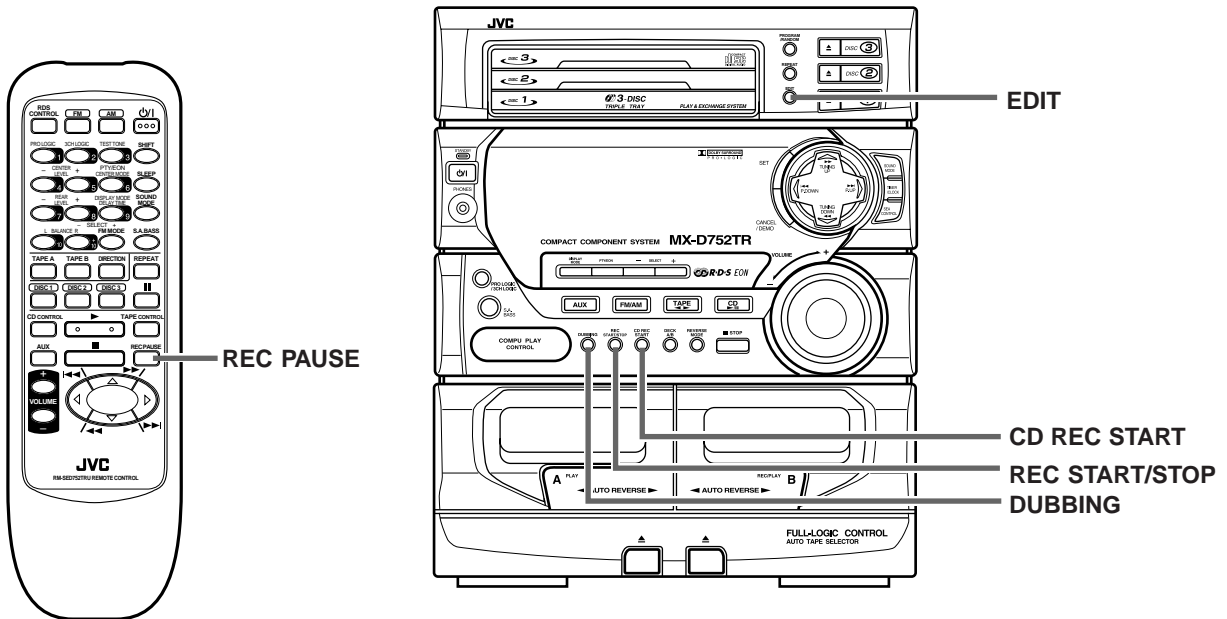

Display

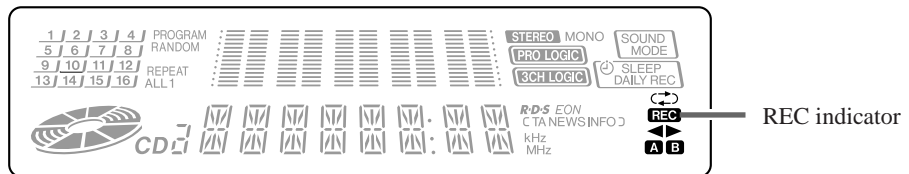

When the System is being used, the display shows other items as well. However, we have only shown the items described in this section.

Things to Know before You Start Recording

- It may be unlawful to record or play back copyrighted material without the consent of the copyright owner.
- When you want to record onto both sides of a tape, you can set Reverse mode on to do so. However, recording automatically stops after recording in the ◀ direction in Reverse mode. Therefore, make sure that the tape direction is ▶ when recording with Reverse mode on.
- The recording level, which is the volume at which the new tape is being made, is automatically set correctly, so it is not affected by volume control. Thus, during recording you can adjust the sound you are actually listening to without affecting the recording level.
- Two small tabs on the back of the cassette tape, one for side A and one for side B, can be removed to prevent accidental erasure or re-recording. To record on a cassette with the tabs removed, you must cover the holes with adhesive tape first. However, when a Type II tape is used, only cover part of the hole as shown, since the other part of the hole is used to detect the tape type.
- When recording, you can hear Sound Mode effects through the speakers or headphones. However, the sound is recorded without Sound Mode effects.
- Type I and Type II tapes can be used for recording.

Note: At the start and end of cassette tapes, there is leader tape which cannot be recorded onto.

Depending on the recording source, the first part of the recording may be missing because of the leader. When recording CDs or radio broadcasts, to get the beginning of the recording on the tape, first wind on the leader before beginning recording.

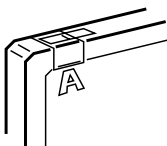

CAUTION: If recordings you have made have excessive noise or static, the Unit may be too close to a TV which was on during recording. Either turn off the TV or increase the distance between the TV and the System.

Standard Recording

This is the basic method for recording any source. The System also has special ways for recording CD to tape, and tape to tape, which save your time and effort, as well as give you some special effects. However, when you need to add a selection to a tape you have made, or are combining selections from several sources on one tape, use the method described below; just substitute the source you want into this procedure, such as a CD or the Tuner. You can also record from an auxiliary source with this procedure.

Using the Unit

1. Insert a blank or erasable tape into Deck B.

2. Press REVERSE MODE if you want to record on both sides of the tape.

Reverse Mode comes on.

- When using Reverse Mode, insert the tape so that it will be recorded in the forward (▶) direction.

3. Check the recording direction for the tape.

Check that the Tape Direction indicator is the same as that for the tape in the tape deck. If the directions are different, press ■ STOP after pressing TAPE ◀▶ to set the tape direction.

- When using the Reverse Mode to record both sides of a tape, check that the Tape Direction indicator is in the forward (▶) direction. If the direction indicator is not in the forward (▶) direction, press TAPE ◀▶ then press ■ STOP.

4. Prepare the source, for example, by tuning in a radio station, loading CDs, or turning on connected equipment.

5. Press REC START/STOP.

The REC indicator lights up and the System begins recording.



Using the Remote Control

1. Insert a blank or erasable tape into Deck B.

2. Press REVERSE MODE on the Unit if you want to record on both sides of the tape.

Reverse Mode comes on.

- When using Reverse Mode, insert the tape so that it will be recorded in the forward (▶) direction.

3. Prepare the source, for example, by tuning in a radio station, loading CDs, or turning on connected equipment.

4. Press REC PAUSE.

The REC indicator starts flashing.



5. Press TAPE CONTROL then press ▶.

Recording starts.

The REC indicator stops flashing and remains lit.



Notes for using Reverse Mode for recording

When recording with Reverse Mode on, the System automatically stops when it reaches the end of the reverse (◀) direction. To record on both sides of a tape, make sure that the recording direction for the tape inserted into Deck B is forward (▶), and that the Tape Direction indicator is also forward (▶), before you start recording.

To pause at any time during the recording process

Press REC PAUSE on the Remote Control. Then press ▶ on the Remote Control or REC START/STOP on the Unit to restart recording.

To stop at any time during the recording process

Press REC START/STOP on the Unit again, or press ■ on the Remote Control.

PROGRAM
/RANDOM

Recording AM Station to Tape

When recording an AM broadcast, beats may be produced which are not heard when listening to the broadcast. In this case, press PROGRAM/RANDOM on the CD Player to eliminate the beats.

1. Set to AM station and start recording.

2. Press PROGRAM/RANDOM repeatedly until the beats are eliminated.

Each time you press the button, the indication on the display changes as follows:
→ CUT 2 → CUT 3 → CUT 4 → CUT 1 → (back to the beginning)

CD Direct Recording

Everything on the CD goes onto the tape in the order it is on the CD, or according to the order you have set in a program.

1. Press CD ►/II, then ■ STOP.

2. Prepare CDs. (See page 24.)

Check that the CD Player is not playing a CD.

3. Insert a blank or erasable cassette in Deck B.

- When you want to record on both sides of a tape, press REVERSE MODE to turn on Reverse Mode. Check that the recording direction for the tape and the Tape Direction indicator are correct. (See page 33 “Notes for using Reverse Mode for recording”.)

4. Press CD REC START.

“CD REC” appears on the display, the REC indicator lights up, and the System begins recording.

If the tape reaches its end while recording a song, the last song will be re-recorded at the beginning of the other side.

When the recording is finished, “CD REC FINISHED” scrolls by on the display. The CD Player and Cassette Deck stop.

CD REC
START

To stop at any time during the recording process, press ■ STOP.

Note: When making Sleep Timer settings while doing CD Direct recording, set the time so that there is enough leeway to finish the recording before the power turns off. If the time is set to about the length of the CD, the power may turn off before recording finishes.

For CD Direct Recording using more than one disc, use a blank tape. If you use a prerecorded tape, prerecorded material may not be erased between newly-recorded tracks.

Auto Edit Recording

Using Auto Edit, you can record the CD tracks to fit the tape, so a selection is not cut off. Auto Edit is one of the best ways to copy all of a CD onto a tape. Auto Edit programs the CD tracks in numerical order. To prevent the end of the last track on the front side from being cut off, the last track on the front side is selected to fit on the remaining tape length.

1. Press CD ►/II, then ■ STOP.

2. Prepare CDs. (See page 24.)

Check that the CD Player is not playing a CD.

3. Press EDIT on the Unit.

“DISC-” appears on the display.

DISC --

4. Press DISC (1 to 3) for the disc you want to record.

After “TAPE C - -”, the optimum tape length for the disc appears on the display.

TAPE [---] → TAPE [70]

- You can select a different length of tape, depending on the actual size of the tape you are using, from eleven possibilities programmed into the Unit: 40, 46, 50, 54, 60, 64, 70, 74, 80, 84, 90. Select the tape length that corresponds to the length of tape you are using, or the nearest length to it, by adjusting ◀◀ P. DOWN or ▶▶ P. UP on the MULTI CONTROL.
- If you select a tape length shorter than the total playing time of the CD, the last tracks on both sides of the tape will be faded out as the tape ends.

EDIT

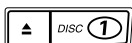
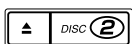
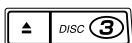

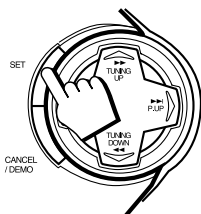

5. Press SET.

The tracks to be recorded on side B appear on the display.

SIDE - B

- Each time you press the button, the tracks to be recorded on side A and side B appear on the display alternately.

6. Insert a blank or erasable cassette in Deck B.

When you want to record on both sides of a tape, press REVERSE MODE to turn Reverse mode on.

7. Press CD REC START.

The Unit plays the CD and starts recording. If the tape has not been rewound, the Unit rewinds the tape before starting to record the CD.

To stop at any time while recording, press ■ STOP or REC START/STOP on the Unit. If ■ STOP is pressed, the Cassette Deck will create a four-second blank space after the CD Player stops. If REC START/STOP is pressed, the CD Player and Cassette Deck will stop simultaneously. When ■ is pressed on the Remote Control, the stop time of the CD Player and Cassette Deck vary according to their mode (CD operation mode or Cassette Deck operation mode). If the Remote Control is in CD operation mode, the Cassette Deck will stop four second after the CD Player stops. If the Remote Control is in Cassette Deck operation mode, the CD Player and Cassette Deck will stop simultaneously.

To cancel Auto Edit, press PROGRAM/RANDOM while the CD Player is stopped or press ▲ for the disc number being recorded.

Note: When making Sleep timer settings while doing Auto Edit recording, set the time so that there is enough leeway to finish the recording before the power goes out. If the time is set to about the length of the CD, the power may go out before recording finishes.

Tape to Tape Recording (Dubbing)

Recording from one tape to another is called dubbing.

- When dubbing tapes, make sure that the playback direction of Deck A and Deck B are the same.
- When you record both sides of a tape, press REVERSE MODE to turn on the Reverse Mode.
- It is preferable that the type of tape (Type I or Type II) you record from be the same as the type you record onto.

How to Use DUBBING

1. Press TAPE ◀ ▶, then ■ STOP.

2. Insert the source cassette you want to copy from into Deck A for playback.

Insert the cassette so that it will be played in the forward (▶) direction.

3. Insert the blank or erasable cassette you want to copy onto into Deck B for recording.

Insert the cassette so that it will be recorded in the forward (▶) direction.

4. Press DUBBING.

Deck A and Deck B start simultaneously.

To stop dubbing, press ■ STOP.



- When dubbing, you can hear Sound Mode effects through the speakers or headphones. However, the sound is dubbed without Sound Mode effects.

Using the Timer

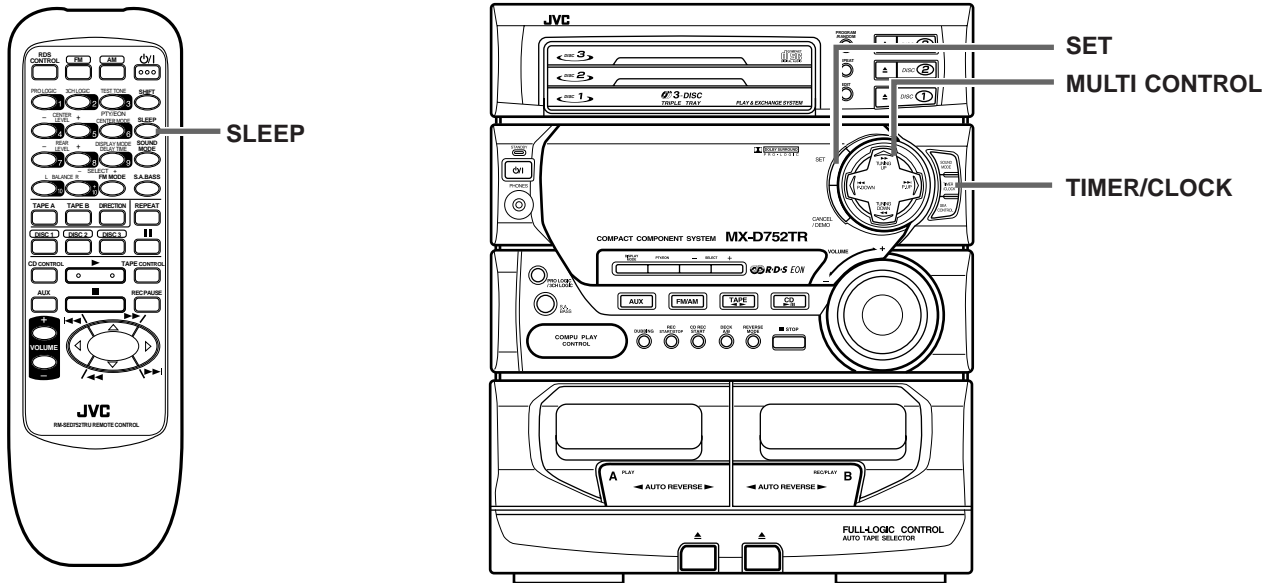

Display

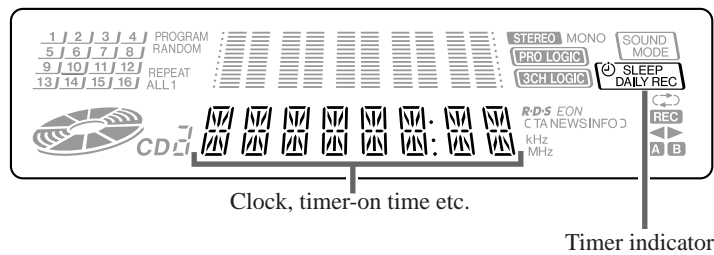

When the System is being used, the display shows other items as well. However, we have only shown the items described in this section.

The timers let you control recording and listening functions automatically.

Three types of timers are available:

- **Daily Timer** — Use this timer to set wake up everyday to music from any source, instead of an alarm clock.
- **Recording Timer** — Unattended recording of radio broadcasts. You can set the starting time and stopping time of the recording.
- **Sleep Timer** — Fall asleep and have your Unit turn off automatically after a certain length of time.

Note: When operating the Daily Timer and Recording Timer, always set the clock first. If the clock is not set, the Daily Timer and Recording Timer functions cannot be used. For details, refer to “Setting the Clock” on page 9.

Setting the Daily Timer

With this timer you can wake up to music from a CD, tape, your favourite radio program.

■ You can set the Daily Timer whether the Unit is on or off.

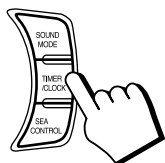

Procedure For Setting the Daily Timer

1. Press TIMER/CLOCK so that "DAILY" appears on the display.

The DAILY indicator flashes on the display.

DAILY

- Each time you press the button, the timer setting indication changes as follows:
DAILY → **ON TIME** (flashes) → **REC** → **ON TIME** (flashes) → Clock setting → Cancelled (current source) → (back to the beginning)

Note: If the clock has not been set, even if TIMER/CLOCK is pressed you cannot select the Daily Timer.

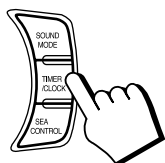

2. Press TIMER/CLOCK again.

After "ON TIME" flashes for 2 seconds, it switches to the on-time setting display.

ON TIME → 0:00
 Flashing

3. Set the time you want the Unit to turn on.

Press ◀◀ P. DOWN or ▶▶ P. UP on the MULTI CONTROL to adjust the hours and press SET. Then press ◀◀ P. DOWN or ▶▶ P. UP to adjust the minutes and press SET.

7:30 → OFF TIME

- After adjusting the minutes and pressing SET, "OFF TIME" flashes for two seconds and on-time setting is completed.

4. Set the time you want the Unit to turn off.

Press ◀◀ P. DOWN or ▶▶ P. UP on the MULTI CONTROL to adjust the hours and press SET. Then press ◀◀ P. DOWN or ▶▶ P. UP to adjust the minutes and press SET.

8:30 → -- [] -- -- --

- When the off-time has been set, the indication on the display changes to the source selection.
- To select the source to be played, press ◀◀ P. DOWN or ▶▶ P. UP on the MULTI CONTROL until your choice is shown.

5. Select the source you want to listen to.

To use a CD as the source:

- Press ◀◀ P. DOWN or ▶▶ P. UP on the MULTI CONTROL repeatedly until "- CD - -" flashes on the display and press SET.

-- [] -- -- --

- Press ◀◀ P. DOWN or ▶▶ P. UP on the MULTI CONTROL repeatedly to select the CD disc number to be played and press SET.

If you press SET without selecting a disc, the last disc played by the Unit will be used.

3 [] -- -- --

- Press ◀◀ P. DOWN or ▶▶ P. UP on the MULTI CONTROL repeatedly to select the CD track number to be played and press SET.

If you press SET without selecting a track, playback will start from the first track on the CD.

3 [] - 05

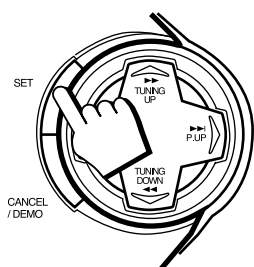
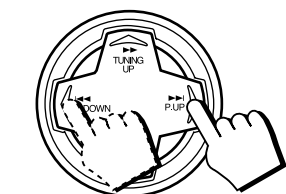

To use the Tuner as the source**(Possible only after presetting stations):**

1. To listen to FM, press ◀◀ P. DOWN or ▶▶ P. UP on the MULTI CONTROL repeatedly until "TUNER FM" flashes and press SET.

To listen to AM, press ◀◀ P. DOWN or ▶▶ P. UP on the MULTI CONTROL repeatedly until "TUNER AM" flashes and press SET.

TUNER FM or TUNER AM

2. Press ◀◀ P. DOWN or ▶▶ P. UP on the MULTI CONTROL repeatedly to select the station to be listened to as a preset channel and press SET.

P -- 5

To use a Cassette Deck as the source:

Press ◀◀ P. DOWN or ▶▶ P. UP on the MULTI CONTROL repeatedly until "TAPE" flashes on the display and press SET.

TAPE

6. Setting the Volume Level.

Press ◀◀ P. DOWN or ▶▶ P. UP on the MULTI CONTROL to adjust the volume.

VOL -- --

VOL - 10: Sets the volume level to 10.

VOL - 15: Sets the volume level to 15.

VOL - 20: Sets the volume level to 20.

VOL - - -: Sets the volume to the last volume setting used.

7. Press SET.

The DAILY indicator stops flashing and remains lit. The on-time, off-time, playback source (including the disc number and track number if a CD source is selected), and volume level appears on the display. Turn the power off if you made the timer settings with the power turned on.

- A few seconds before the on-time, the Unit automatically turns on the power. When the on-time comes, playback starts using the selected source. A few seconds before the off-time, "OFF" flashes on the display. When the off-time comes, the power is automatically turned off.
- If a button is pressed when the Daily Timer is operating, playback continues but the timer is cancelled.

Before turning off the Unit

- If the source is a CD, make sure that there is a CD in the selected disc number.
- If the source is a tape:
 - The tape in the deck corresponding to the Deck indicator mark is played. Make sure that there is a tape in the selected Cassette Deck.
 - Check that the tape direction is correct. This is important especially when Reverse Mode is off.
 - Set Reverse Mode on if you want to play both sides of the tape.
- Select the Sound Mode if you want to listen using a Sound Mode effect.

To change the Daily Timer setting

To change the settings for the Daily Timer, repeat the setting procedure from the beginning.

Turning the Daily Timer On and Off

Once the Daily Timer has been set it will be activated at the same time every day until the setting is turned off.

To turn the Daily Timer off, press TIMER/CLOCK until "DAILY" appears on the display. Press CANCEL/DEMO. "OFF" appears on the display and the DAILY indicator goes out.

To turn the Daily Timer on again, press TIMER/CLOCK until "DAILY" appears on the display, then press SET. The Timer on-time, off-time, playback source (including the disc number and track number if a CD source is selected), and volume level appear on the display, and the DAILY indicator lights up.

CAUTION: If the Unit is unplugged, or a power failure occurs, the timer setting will be erased in a few days. If the settings are erased in this way, reset the timer settings.

Setting the Recording Timer

With the Recording Timer you can make a tape of a radio broadcast automatically whether or not you are home. For the timer to work correctly, you need to make sure of the following in addition to setting the time for the Tuner and Cassette Deck to come on:

- You can set the Recording Timer whether the Unit is on or off.
- The tape you want to record onto must be in Deck B.

Procedure for Setting the Recording Timer

- 1. Press TIMER/CLOCK repeatedly until “REC” appears on the display.**
The REC indicator flashes on the display.

REC

- Each time you press the button, the timer setting indication changes as follows:
DAILY → **ON TIME** (flashes) → **REC** → **ON TIME** (flashes) → Clock setting → Cancelled (current source) → (back to the beginning)

Note: If the clock has not been set, even if TIMER/CLOCK is pressed you cannot select the Recording Timer.

- 2. Press TIMER/CLOCK again.**

After “ON TIME” flashes for 2 seconds, it switches to the time setting display.

- 3. Set the time you want the Unit to be turned on.**

Press ◀◀ P. DOWN or ▶▶ P. UP on the MULTI CONTROL to adjust the hours and press SET. Then press ◀◀ P. DOWN or ▶▶ P. UP to adjust the minutes and press SET.

- 4. Set the time you want the Unit to be turned off.**

Press ◀◀ P. DOWN or ▶▶ P. UP on the MULTI CONTROL to adjust the hours and press SET. Then press ◀◀ P. DOWN or ▶▶ P. UP to adjust the minutes and press SET.

- 5. Select the Recording band.**

Press ◀◀ P. DOWN or ▶▶ P. UP on the MULTI CONTROL to select “TUNER FM” or “TUNER AM” and press SET.

- 6. Select the preset channel for the station to be recorded.**

Press ◀◀ P. DOWN or ▶▶ P. UP on the MULTI CONTROL to select.

- 7. Press SET.**

The REC indicator stops flashing and remains lit. The on-time, off-time, and Recording band (“TUNER FM” or “TUNER AM”) appear on the display.

Turn the power off if you made the timer settings with the power turned on.

- A few seconds before the on-time for the recording, the Unit automatically turns on the power. When the on-time comes, recording starts using the selected source. A few seconds before the off-time, “OFF” flashes on the display. When the off-time comes, the power is automatically turned off.

Before the timer starts

- Check that tape direction is correct. This is important especially when Reverse Mode is off.
- Set Reverse Mode on if you want to record on both sides of the tape.
- The volume level is automatically set to 0 when Recording Timer starts.

It is very easy, and can be very disappointing, to forget to put in a tape, or to accidentally leave a tape in Deck B you don't want recorded over. Although this happens to almost everyone at one time or another, we hope it won't happen to you!

To change the Recording Timer setting

Repeat the setting procedure from the beginning.

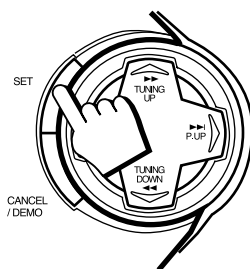
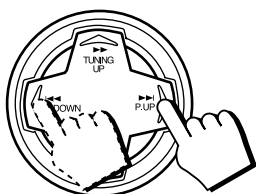
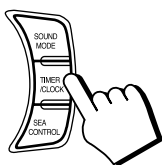
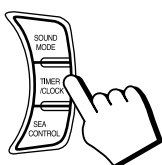

Turning the Recording Timer On and Off

Once the Recording Timer has been used, the setting is maintained but the Timer is set to off.

To turn the Recording Timer off before the timer starts, press TIMER/CLOCK repeatedly until “REC” appears on the display, then press CANCEL/DEMO. “OFF” appears on the display and the REC indicator goes out.

To record at the same time again, press TIMER/CLOCK repeatedly until “REC” appears on the display, then press SET. The on-time, off-time, and Recording band (“TUNER FM” or “TUNER AM”) appear on the display, and the REC indicator lights up.

CAUTION: If the Unit is unplugged, or a power failure occurs, the timer setting will be erased in a few days. If the settings are erased in this way, reset the timer settings.

Setting the Sleep Timer

Use the Sleep Timer to turn the Unit off after a certain number of minutes when it is playing. By setting this timer, you can fall asleep to music and know your Unit will turn off by itself rather than play all night.

■ You can only set the Sleep Timer when the Unit is on and a source is playing.

To set the SLEEP Timer, follow this procedure:

1. With the Unit on and a source playing, press SLEEP on the Remote Control.

“SLEEP” appears on the display.



SLEEP 10

2. Set the length of time you want the source to play before shutting off.

- Each time you press this button while the SLEEP indicator is flashing, it changes the number of minutes shown on the display in this sequence:

→ 10 → 20 → 30 → 60 → 90 → 120 → Cancelled → (back to the beginning)

When the number of minutes you want shows on the display, just wait 5 seconds until the indicator stops flashing, and remains lit.

The Unit is now set to turn off after the number of minutes you set.

To change the Sleep Timer setting

Press SLEEP until the number of minutes you want appears on the display.

To cancel the Sleep Timer setting

Press SLEEP until the SLEEP indicator goes out on the display.

Turning off the Unit also cancels the Sleep Timer.

Timer Priority

Since each timer can be set independently, you may wonder what happens if the settings overlap. Here are the priorities for each timer:

- The Recording Timer always has priority. This means that:
 - If another timer is set to come on during a time when the Recording Timer is operating, the other timer just will not come on at all, so you will always get the entire program on tape.
 - If the Recording Timer is set to come on while another timer is operating, the other timer will shut off 10 seconds before the Recording Timer is set to turn on, and the Recording Timer will then take over.
- If the Sleep Timer is set while the Daily Timer is operating, the Sleep Timer will take over. However, if the Daily Timer is set to come while the Sleep Timer is operating, the Daily Timer will take over.

Example 1

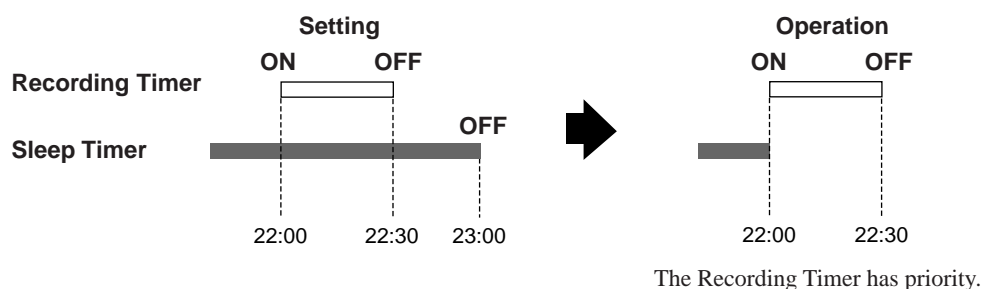

Example 2

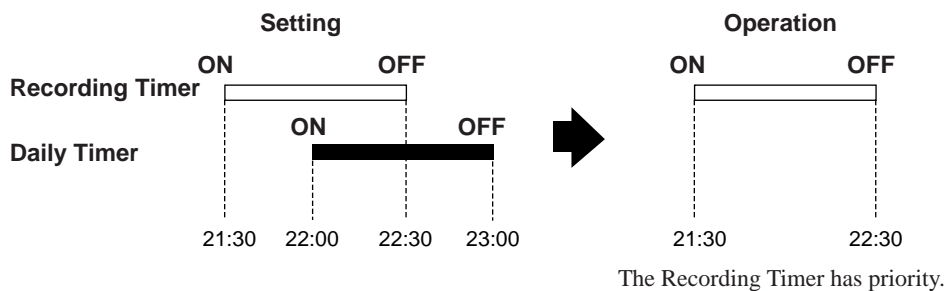

Care and Maintenance

Compact Discs

Handle your compact discs, cassette tapes, and Cassette Deck carefully, and they will last a long time.



- Remove the CD from the case by holding it at the edges while pressing the center hole lightly.
- Do not touch the shiny surface of the CD, or bend the CD.



- Put the CD back in its case after use to prevent warping.
- Be careful not to scratch the surface of the CD when placing it back in the case.
- Avoid exposure to direct sunlight, temperature extremes, and moisture.



- A dirty CD may not play correctly. If a CD does become dirty, wipe it with a soft cloth in a straight line from center to edge.

CAUTION: Do not use any solvent (for example, conventional record cleaner, spray thinner, benzene, etc.) to clean a CD.

Moisture Condensation



Moisture may condense on the lens inside the Unit in the following cases:

- After starting the heating in the room.
- In a damp room.
- If the Unit is brought directly from a cold to a warm place.

Should this occur, the Unit may malfunction. In this case, leave the Unit turned on for a few hours until the moisture evaporates, unplug the AC power cord, and then plug it in again.

General Notes

In general, you will have the best performance by keeping your tapes, CDs, and the mechanism clean.

- Store tapes and CDs in their cases, and keep them in cabinets or on shelves.
- Keep the Cassette Deck's tape doors and the CD trays closed when not in use.

Cassette Tapes

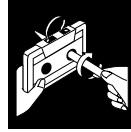

- If the tape is loose in its cassette, take up the slack by inserting a pencil in one of the reels and rotating.
- If the tape is loose, it may get stretched, cut, or caught in the cassette.

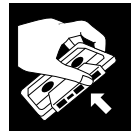

- Do not touch the tape surface.

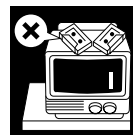

- Do not store the tape:
 - In dusty places
 - In direct sunlight or heat
 - In moist areas
 - On a TV or speaker
 - Near a magnet

Cassette Deck

- If the heads, capstans, and pinch-rollers of the Cassette Deck become dirty, the following will occur:
 - Loss of sound quality
 - Discontinuous sound
 - Fading
 - Incomplete erasure
 - Difficulty recording
- Clean the heads, capstans, and pinch-rollers using a cotton swab moistened with alcohol.

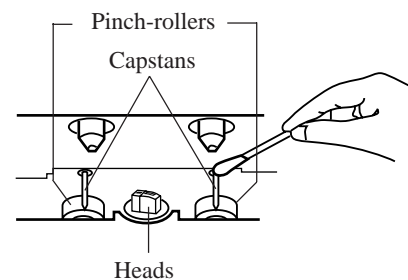

- If the heads become magnetized, the Unit will produce noise or lose high frequencies.
- To demagnetize the heads, turn off the Unit, and use a head demagnetizer (available at electronics and record shops).

Troubleshooting

- If you are having a problem with your System, check this list for a possible solution before calling for service.
- If you cannot solve the problem from the hints given here, or the Unit has been physically damaged, call a qualified person, such as your dealer, for service.

Symptom	Possible Cause	Action
No sound is heard.	Connections are incorrect, or loose.	Check all connections and make corrections. (See pages 4 - 6.)
Unable to record.	Cassette record protect tabs are removed.	Cover holes on back edge of cassette with tape.
Poor radio reception	<ul style="list-style-type: none"> • The antenna is disconnected. • The AM Loop Antenna is too close to the Unit. • The FM Wire Antenna is not properly extended and positioned. 	<ul style="list-style-type: none"> • Reconnect the antenna securely. • Change the position and direction of the AM Loop Antenna. • Extend FM Wire Antenna to the best reception position.
The CD skips.	The CD is dirty or scratched.	Clean or replace the CD.
Unable to operate the Remote Control.	<ul style="list-style-type: none"> • The path between the Remote Control and the sensor on the Unit is blocked. • The batteries have lost their charge. 	<ul style="list-style-type: none"> • Remove the obstruction. • Replace the batteries.
The CD tray cannot be opened.	The main AC power cord is not plugged in.	Plug in the AC power plug.
The CD does not play.	The CD is upside down.	Put the CD in with the label side up.
Operations are disabled.	The built-in microprocessor has malfunctioned due to external electrical interference.	Unplug the Unit then plug it back in.
The cassette door cannot be opened.	During tape playing, the power cord was unplugged.	Plug in the power cord, press ⏻/I , and then press ▶ .

Specifications

Amplifier Section

Output Power (IEC 268-3/DIN)

Front	45 watts per channel, min. RMS, both channels driven into 6 ohms at 1 kHz with no more than 0.9% total harmonic distortion.
Centre	25 watts, min. RMS, driven into 8 ohms at 1 kHz with no more than 0.9% total harmonic distortion.
Rear	12.5 watts per channel, min. RMS, both channels driven into 16 ohms at 1 kHz with no more than 0.9% total harmonic distortion.

Input Sensitivity/Impedance (1 kHz)

AUX	300 mV/50 kohms
Speaker terminals	6 - 16 ohms

Cassette Deck Section

Frequency Response

Type II (CrO ₂) :	50 - 14,000 Hz
Type I (NORMAL) :	50 - 14,000 Hz
Wow And Flutter	0.15% (WRMS)

CD Automatic Changer Section

CD Capacity	3 discs
Dynamic Range	85 dB
Signal-To-Noise Ratio	90 dB
Wow And Flutter	Unmeasurable

Tuner Section

FM Tuner	
Tuning Range	87.5 - 108.0 MHz
AM Tuner	
Tuning Range	
MW	522 - 1,629 kHz
LW	144 - 288 kHz
Dimensions	265 × 315 × 340 mm (W/H/D) (10-7/16 × 12-7/16 × 13-7/16 inches)
Mass	9.0 kg (19.8 lbs)

Accessories

AM (MW/LW) Loop Antenna	(1)
Remote Control	(1)
Batteries R6P (SUM-3)/AA (15F)	(2)
FM Wire Antenna	(1)

Power Specifications

Power Requirements	AC 230 V ~, 50 Hz
Power Consumption	160 watts 12 watts (in standby mode)

Design and specifications are subject to change without notice.

